

na·De®

FIYAT LİSTESİ OCAK 2018



49
Yı

Aydınlık Günlerinizin Güvencesi



na·De®

Bina otomasyon ve bina iletişim sistemleri sektöründe faaliyetine 70'li yıllarda başlamış olan firmamız bu 48 yılı aşkın süre sonunda oldukça uzun bir yol kat ederek sektöründe öncü bir isim haline gelmiştir. Her geçen gün büyüyen yapısına stratejik uygunluk sağlanabilmesi açısından üretim sahasını 15.000 m² alana çıkararak modern üretim teknikleri ve son teknoloji üretim makineleri ile Tuzla fabrikasında konumlanmıştır.

Na-De, yola çıktığı günden bugünlere kadar müşteri memnuniyetlerini ön planda tutarak önceliği müşterilerine tanımış; yurtiçi ve yurtdışı fuar katılımları ile de diyaloglarını pekiştirmiştir. Toplam kalite felsefesi ile hareket eden firmamız, memnun müşterilere - mutlu çalışanlara giden başarı çizgisini, kesintisiz gerçekleştirdiği AR-GE çalışmalarına, pazara uygun makul fiyat seviyesine, yetkin kurumlar tarafından tescillenmiş uluslararası kalitesine, özette kaliteyi yaşam biçimi olarak benimsemesine borçludur. Na-De, önüne geçilemeyen hız ve enerji ile rakiplerini gerilerde bırakarak sürekli geleceğe yönelik sağlam adımlarla ilerlemekte ve gelişmektedir. İzlemiş olduğu kalite politikaları ve AR-GE faaliyetleri sonucu üretim tekniklerinde kaydettiği ilerlemelerle modernizasyon girişimleriyle kendisini ve üretim portföyünü yenilemektedir. Na-De yakaladığı bugünkü çizgisi ile sektörde oldukça iddialı bir yer edinmiştir. Modern altyapısı ve test cihazlarıyla her türlü donanımına sahip laboratuvarlarında AR-GE faaliyetleri yürütecek uzun vadeli çalışmaların sonucu olarak %100 Türk Malı yerli üretim ilk Hareket Sensörünün ve Hareket Sensörlü Tavan ve Duvar Tipi Aydınlatma Armatürlerini de yeni tasarım ürünler yelpazesine eklemiş ve siz müşterilerimizin hizmetine sunmuş bulunmaktadır. Na-De, üretimini en son teknoloji, makine ve donanım ile gerçekleştirmekte, Ulusal (TSE) ve uluslararası standartlara (ISO 9001. CE) uygun olan ürünlerini iç ve dış piyasaya sunmaktadır.

Misyonumuz; müşterilerimizi yurtiçinde ve yurtdışında kalitesiz ürün üretmekte olan firmalara bağlı olmaktan kurtarmak, dış pazarlarda söz sahibi olmak, ürünlerimizi son teknoloji ile üreterek müşterilerimize nitelikli alternatifler sunmaktır. Gelişen teknolojiye ayak uydurarak müşterilerimiz ve çalışanlarımızın işbirliği ile iç piyasadaki lider konumumuzu korumak ve güçlendirmek, küreselleşen dünya pazarında tercih edilen marka konumuna gelebilmek, toplam kalite felsefesini tüm yönetim ve uygulama kademelerinde en iyi şekilde gerçekleştirmeye çalışmaktır.



NA-DE Elektronik, DMY Elektronik Yatırımlar Grup Şirkettir.
(www.dmyelektronik.com)



na·De®





































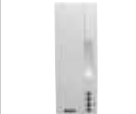





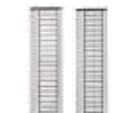



















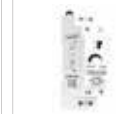

na·De®



INDEX

INTERKOM SİSTEMLERİ

 V-8 S.11 N2307ADT-8 7\" data-bbox="100 215 185 255"/>	 V-8 S.11 N2804ADT-8 4.3\" data-bbox="200 215 285 255"/>	 V-8 S.12 N28AC 7\" data-bbox="300 215 385 255"/>	 V-8 S.12 N28BC 7\" data-bbox="400 215 485 255"/>	 V-8 S.13 N1607BCR 7\" data-bbox="500 215 585 255"/>	 V-8 S.13 NV03 7\" data-bbox="600 215 685 255"/>	 V-8 S.13 PW01.1 7\" data-bbox="700 215 785 255"/>	 V-BUS9 S.16 N2307ADT 7\" data-bbox="800 215 885 255"/>
 V-BUS9 S.16 N280ADT 4.3\" data-bbox="100 315 185 355"/>	 V-BUS9 S.17 N28AC 7\" data-bbox="200 315 285 355"/>	 V-BUS9 S.17 N28BC 7\" data-bbox="300 315 385 355"/>	 V-BUS9 S.18 N1607BCR 7\" data-bbox="400 315 485 355"/>	 V-BUS9 S.18 NH01 7\" data-bbox="500 315 585 355"/>	 V-BUS9 S.18 NH02 7\" data-bbox="600 315 685 355"/>	 V-BUS9 S.19 NH03 7\" data-bbox="700 315 785 355"/>	 V-BUS9 S.19 NV01 7\" data-bbox="800 315 885 355"/>
 V-BUS9 S.19 PW01.1 7\" data-bbox="100 415 185 455"/>	 V-BUS9 S.19 NC01 7\" data-bbox="200 415 285 455"/>	 V-BUS7 S.22 NVM-800MCW (BEYAZ) 7\" data-bbox="300 415 385 455"/>	 V-BUS7 S.22 NVM-800MCB (SİYAH) 7\" data-bbox="400 415 485 455"/>	 V-BUS7 S.23 NVM-430MC 4.3\" data-bbox="500 415 585 455"/>	 V-BUS7 S.23 NVM-360MC 3.5\" data-bbox="600 415 685 455"/>	 V-BUS7 S.24 NVM-350MCW (BEYAZ) 3.5\" data-bbox="700 415 785 455"/>	 V-BUS7 S.24 350MCB (SİYAH) 3.5\" data-bbox="800 415 885 455"/>
 V-BUS7 S.25 ND-110-8 7\" data-bbox="100 515 185 555"/>	 V-BUS7 S.25 ND-105-7 7\" data-bbox="200 515 285 555"/>	 V-BUS7 S.25 ND-106-7 7\" data-bbox="300 515 385 555"/>	 V-BUS7 S.26 ND-101-8 7\" data-bbox="400 515 485 555"/>	 V-BUS7 S.26 ND-101CT-8 7\" data-bbox="500 515 585 555"/>	 V-BUS7 S.27 8NDKC 7\" data-bbox="600 515 685 555"/>	 V-BUS7 S.27 8NDKC-ID 7\" data-bbox="700 515 785 555"/>	 V-BUS7 S.28 8NDK-XX 7\" data-bbox="800 515 885 555"/>
 V-BUS7 S.29 NDK-1S20 / 1S40 7\" data-bbox="100 615 185 655"/>	 V-BUS7 S.29 Butonlu TİP EK ZİL PANELİ 7\" data-bbox="200 615 285 655"/>	 V-BUS7 S.30 ZİL PANELİ KOŞE APARATLARI 7\" data-bbox="300 615 385 655"/>	 V-BUS7 S.30 ZİL PANELİ YAĞMURLUK APARATLARI 7\" data-bbox="400 615 485 655"/>	 V-BUS7 S.31 GK-04-8 7\" data-bbox="500 615 585 655"/>	 V-BUS7 S.31 RF-ID 7\" data-bbox="600 615 685 655"/>	 V-BUS7 S.31 ND-103 7\" data-bbox="700 615 785 655"/>	 V-BUS7 S.31 ND-104 7\" data-bbox="800 615 885 655"/>
 V-BUS7 S.31 ND-200 7\" data-bbox="100 715 185 755"/>	 MULTİ APARTMAN DİAFON SİSTEMLERİ S.36 50010 7\" data-bbox="200 715 285 755"/>	 MULTİ APARTMAN DİAFON SİSTEMLERİ S.36 50012 7\" data-bbox="300 715 385 755"/>	 MULTİ APARTMAN DİAFON SİSTEMLERİ S.36 50014 7\" data-bbox="400 715 485 755"/>	 MULTİ APARTMAN DİAFON SİSTEMLERİ S.37 50040 7\" data-bbox="500 715 585 755"/>	 MULTİ APARTMAN DİAFON SİSTEMLERİ S.37 50041 7\" data-bbox="600 715 685 755"/>	 MULTİ APARTMAN DİAFON SİSTEMLERİ S.38 50022 7\" data-bbox="700 715 785 755"/>	 MULTİ APARTMAN DİAFON SİSTEMLERİ S.38 50032 7\" data-bbox="800 715 885 755"/>
 MULTİ APARTMAN DİAFON SİSTEMLERİ S.39 APARTMAN TİPİ TEK BUTONLU DİAFON ZİL PANELLERİ 7\" data-bbox="100 815 185 855"/>	 MULTİ APARTMAN DİAFON SİSTEMLERİ S.40 APARTMAN TİPİ ÇİFT BUTONLU DİAFON ZİL PANELLERİ 7\" data-bbox="200 815 285 855"/>	 VİLLA SET S.45 7\" data-bbox="300 815 385 855"/>	 VİLLA SET S.46 4 DAİRE'YE KADAR EKONOMİK SETLER 7\" data-bbox="400 815 485 855"/>	 VİLLA SET S.46 20 DAİRE'YE KADAR EKONOMİK SETLER 7\" data-bbox="500 815 585 855"/>	 MERDİVEN VE KAPI OTOMATİKLERİ S.48 W OTOMAT TİPİ MERDİVEN OTOMATIĞI 16A 03006 7\" data-bbox="600 815 685 855"/>	 MERDİVEN VE KAPI OTOMATİKLERİ S.48 W OTOMAT TİPİ MERDİVEN OTOMATIĞI 10A 03009 7\" data-bbox="700 815 785 855"/>	 MERDİVEN VE KAPI OTOMATİKLERİ S.48 DÖKÜM KAPI OTOMATIĞI (MEKANLI BUTONLU) 03004 7\" data-bbox="800 815 885 855"/>
 ZİL TRANSFORMATÖRLERİ S.48 12V / 4VA AC ZİL TRANSFORMATÖRÜ 01004 7\" data-bbox="100 915 185 955"/>	 ZİL TRANSFORMATÖRLERİ S.49 15V / 15VA ZİL TRANSFORMATÖRÜ 01002 7\" data-bbox="200 915 285 955"/>	 ZİL TRANSFORMATÖRLERİ S.49 24V / 15VA ZİL TRANSFORMATÖRÜ 01003 7\" data-bbox="300 915 385 955"/>	 ZİL TRANSFORMATÖRLERİ S.49 15V / 30VA AC ZİL TRANSFORMATÖRÜ 01005 7\" data-bbox="400 915 485 955"/>	 ZİL TRANSFORMATÖRLERİ S.49 24V / 50VA AC ZİL TRANSFORMATÖRÜ 01006 7\" data-bbox="500 915 585 955"/>	 ZİL BUTONLARI S.50 ALÜMİNYUM ZİL BUTONLARI 7\" data-bbox="600 915 685 955"/>	 ZİL BUTONLARI S.50 LED'LI IŞIKLI ZİL BUTONLARI 7\" data-bbox="700 915 785 955"/>	

YANGIN ALARM VE ACİL AYDINLATMA & YÖNLENDİRME SİSTEMLERİ

 YANGIN ALARM SİSTEMLERİ S.52 ADRESLENEBİLİR YANGIN ALARM SANTRALLERİ IFS7002 YANGIN ALARM SANTRALİ	 YANGIN ALARM SİSTEMLERİ S.52 ADRESLENEBİLİR YANGIN ALARM SANTRALLERİ IFS7002/2 YANGIN ALARM SANTRALİ	 YANGIN ALARM SİSTEMLERİ S.52 ADRESLENEBİLİR YANGIN ALARM SANTRALLERİ IFS7002/4 YANGIN ALARM SANTRALİ	 YANGIN ALARM SİSTEMLERİ S.52 ADRESLENEBİLİR YANGIN ALARM SANTRALLERİ IFS7002/R YANGIN ALARM SANTRALİ	 YANGIN ALARM SİSTEMLERİ S.53 ADRESLENEBİLİR YANGIN ALARM DEDEKTÖRLERİ FD7110 SABİT İSİ DEDEKTÖRÜ	 YANGIN ALARM SİSTEMLERİ S.53 ADRESLENEBİLİR YANGIN ALARM DEDEKTÖRLERİ FD7120 İSİ VE İSİ ARTIŞ DEDEKTÖRÜ	 YANGIN ALARM SİSTEMLERİ S.53 ADRESLENEBİLİR YANGIN ALARM DEDEKTÖRLERİ FD7130 OPTİK DUMAN DEDEKTÖRÜ
 YANGIN ALARM SİSTEMLERİ S.53 ADRESLENEBİLİR YANGIN ALARM DEDEKTÖRLERİ FD7160 DUMAN VE İSİ DEDEKTÖRÜ	 YANGIN ALARM SİSTEMLERİ S.54 ADRESLENEBİLİR YANGIN ALARM BUTONU FD7150 YANGIN ALARM BUTONU	 YANGIN ALARM SİSTEMLERİ S.54 ADRESLENEBİLİR YANGIN ALARM AKSESUARLARI - 7000 SERİSİ FD7201S ADAPTÖR	 YANGIN ALARM SİSTEMLERİ S.54 ADRESLENEBİLİR YANGIN ALARM AKSESUARLARI - 7000 SERİSİ FD7201SA	 YANGIN ALARM SİSTEMLERİ S.54 ADRESLENEBİLİR YANGIN ALARM AKSESUARLARI - 7000 SERİSİ FD7203	 YANGIN ALARM SİSTEMLERİ S.55 ADRESLENEBİLİR YANGIN ALARM AKSESUARLARI - 7000 SERİSİ FD7203 10/16	 YANGIN ALARM SİSTEMLERİ S.55 ADRESLENEBİLİR YANGIN ALARM AKSESUARLARI - 7000 SERİSİ FD7203 3/6
 YANGIN ALARM SİSTEMLERİ S.55 ADRESLENEBİLİR YANGIN ALARM AKSESUARLARI - 7000 SERİSİ FD7203R	 YANGIN ALARM SİSTEMLERİ S.55 ADRESLENEBİLİR YANGIN ALARM AKSESUARLARI - 7000 SERİSİ FD7204 SİREN	 YANGIN ALARM SİSTEMLERİ S.55 ADRESLENEBİLİR YANGIN ALARM AKSESUARLARI - 7000 SERİSİ FD7204F SİREN	 YANGIN ALARM SİSTEMLERİ S.56 ADRESLENEBİLİR YANGIN ALARM AKSESUARLARI - 7000 SERİSİ TR6100-1 20-40 İŞİN TİPİ DUMAN DEDEKTÖRÜ	 YANGIN ALARM SİSTEMLERİ S.56 ADRESLENEBİLİR YANGIN ALARM AKSESUARLARI - 7000 SERİSİ TR6100-2 40-70 İŞİN TİPİ DUMAN DEDEKTÖRÜ	 YANGIN ALARM SİSTEMLERİ S.56 ADRESLENEBİLİR YANGIN ALARM AKSESUARLARI - 7000 SERİSİ TR6100-3 70-100 İŞİN TİPİ DUMAN DEDEKTÖRÜ	 YANGIN ALARM SİSTEMLERİ S.56 ADRESLENEBİLİR YANGIN ALARM AKSESUARLARI - 7000 SERİSİ DB7100 TABAN
 YANGIN ALARM SİSTEMLERİ S.56 ADRESLENEBİLİR YANGIN ALARM AKSESUARLARI - 7000 SERİSİ CYS-4024 GÜÇ KAYNAĞI	 YANGIN ALARM SİSTEMLERİ S.56 ADRESLENEBİLİR YANGIN ALARM AKSESUARLARI - 7000 SERİSİ CYS-9024 GÜÇ KAYNAĞI	 YANGIN ALARM SİSTEMLERİ S.56 ADRESLENEBİLİR YANGIN ALARM AKSESUARLARI - 7000 SERİSİ CYS-12024 GÜÇ KAYNAĞI	 YANGIN ALARM SİSTEMLERİ S.56 ADRESLENEBİLİR YANGIN ALARM AKSESUARLARI - 7000 SERİSİ CYS-18024 GÜÇ KAYNAĞI	 YANGIN ALARM SİSTEMLERİ S.57 ADRESLENEBİLİR YANGIN ALARM AKSESUARLARI - 7000 SERİSİ NYS1.1 DOĞAL GAZ DEDEKTÖRÜ	 YANGIN ALARM SİSTEMLERİ S.57 ADRESLENEBİLİR YANGIN ALARM AKSESUARLARI - 7000 SERİSİ FXDC0 KARBONMOMOKSİT DEDEKTÖRÜ	 YANGIN ALARM SİSTEMLERİ S.57 ADRESLENEBİLİR YANGIN ALARM AKSESUARLARI - 7000 SERİSİ FXDC01 KARBONMOMOKSİT DEDEKTÖRÜ
 YANGIN ALARM SİSTEMLERİ S.57 ADRESLENEBİLİR YANGIN ALARM AKSESUARLARI - 7000 SERİSİ FXDC02 KARBONMOMOKSİT DEDEKTÖRÜ	 YANGIN ALARM SİSTEMLERİ S.57 NDE01 DOĞALGAZ DEDEKTÖRÜ	 YANGIN ALARM SİSTEMLERİ S.57 TAMMY2 DEPREM SENSÖRÜ	 YANGIN ALARM SİSTEMLERİ S.57 TAMMY3 DEPREM SENSÖRÜ	 YANGIN ALARM SİSTEMLERİ S.57 NYS DOĞAL GAZ DEDEKTÖRÜ	 YANGIN ALARM SİSTEMLERİ S.58 KONVANSİYONEL YANGIN ALARM SİSTEMLERİ - 4000 SERİSİ FS4000/2 YANGIN ALARM SANTRALİ	 YANGIN ALARM SİSTEMLERİ S.58 KONVANSİYONEL YANGIN ALARM SİSTEMLERİ - 4000 SERİSİ FS4000/4 YANGIN ALARM SANTRALİ
 YANGIN ALARM SİSTEMLERİ S.58 KONVANSİYONEL YANGIN ALARM SİSTEMLERİ - 4000 SERİSİ FS4000/6 YANGIN ALARM SANTRALİ	 YANGIN ALARM SİSTEMLERİ S.58 KONVANSİYONEL YANGIN ALARM SİSTEMLERİ - 4000 SERİSİ FS4000/8 YANGIN ALARM SANTRALİ	 YANGIN ALARM SİSTEMLERİ S.59 KONVANSİYONEL YANGIN ALARM SİSTEMLERİ - 5200 SERİSİ FD4201/2 GENİŞLEME MODÜLÜ	 YANGIN ALARM SİSTEMLERİ S.59 KONVANSİYONEL YANGIN ALARM SİSTEMLERİ - 5200 SERİSİ FD4201/4 GENİŞLEME MODÜLÜ	 YANGIN ALARM SİSTEMLERİ S.59 KONVANSİYONEL YANGIN ALARM SİSTEMLERİ - 5200 SERİSİ FD4201/6 GENİŞLEME MODÜLÜ	 YANGIN ALARM SİSTEMLERİ S.59 KONVANSİYONEL YANGIN ALARM SİSTEMLERİ - 5200 SERİSİ FD4201/8 GENİŞLEME MODÜLÜ	 YANGIN ALARM SİSTEMLERİ S.60 KONVANSİYONEL YANGIN ALARM SİSTEMLERİ - 5100 SERİSİ FS5100 YANGIN ALARM SANTRALİ
 YANGIN ALARM SİSTEMLERİ S.60 KONVANSİYONEL YANGIN ALARM SİSTEMLERİ - 5100 SERİSİ 5101 GENİŞLEME MODÜLÜ	 YANGIN ALARM SİSTEMLERİ S.60 KONVANSİYONEL YANGIN ALARM SİSTEMLERİ - 5100 SERİSİ 5102 GENİŞLEME MODÜLÜ	 YANGIN ALARM SİSTEMLERİ S.61 KONVANSİYONEL YANGIN ALARM SİSTEMLERİ - 5200 SERİSİ FS200 YANGIN ALARM SANTRALİ	 YANGIN ALARM SİSTEMLERİ S.61 KONVANSİYONEL YANGIN ALARM SİSTEMLERİ - 5200 SERİSİ 5201 GENİŞLEME MODÜLÜ	 YANGIN ALARM SİSTEMLERİ S.61 KONVANSİYONEL YANGIN ALARM SİSTEMLERİ - 5200 SERİSİ 5202 GENİŞLEME MODÜLÜ	 YANGIN ALARM SİSTEMLERİ S.61 KONVANSİYONEL YANGIN ALARM SİSTEMLERİ - 5200 SERİSİ 5203 GENİŞLEME MODÜLÜ	 YANGIN ALARM SİSTEMLERİ S.62 KONVANSİYONEL YANGIN ALARM SİSTEMLERİ - 5200 SERİSİ 5204 GENİŞLEME MODÜLÜ
 YANGIN ALARM SİSTEMLERİ S.62 KONVANSİYONEL YANGIN ALARM SİSTEMLERİ - 5200E SERİSİ FSS200E YANGIN SÖNDÜRME SANTRALİ	 YANGIN ALARM SİSTEMLERİ S.62 KONVANSİYONEL YANGIN ALARM SİSTEMLERİ - 5200E SERİSİ FD5301 TEKRARLAYICI PANEL	 YANGIN ALARM SİSTEMLERİ S.63 KONVANSİYONEL YANGIN ALARM SİSTEMLERİ - 5200E SERİSİ FD3050Y	 YANGIN ALARM SİSTEMLERİ S.63 KONVANSİYONEL YANGIN ALARM SİSTEMLERİ - 5200E SERİSİ FD3050G	 YANGIN ALARM SİSTEMLERİ S.63 KONVANSİYONEL YANGIN ALARM SİSTEMLERİ - 5200E SERİSİ FD3050B	 YANGIN ALARM SİSTEMLERİ S.63 KONVANSİYONEL YANGIN ALARM SİSTEMLERİ - 5200E SERİSİ 5302	 YANGIN ALARM SİSTEMLERİ S.64 KONVANSİYONEL YANGIN ALARM EKİPMANLARI FD8010





























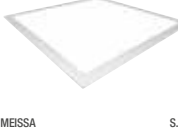

















INDEX

YANGIN ALARM VE ACİL AYDINLATMA & YÖNLENDİRME SİSTEMLERİ

 <p>YANGIN ALARM SİSTEMLERİ S.64 KONVANSİYONEL YANGIN ALARM EKİPMANLARI FD8020</p>	 <p>YANGIN ALARM SİSTEMLERİ S.64 KONVANSİYONEL YANGIN ALARM EKİPMANLARI FD8030</p>	 <p>YANGIN ALARM SİSTEMLERİ S.64 KONVANSİYONEL YANGIN ALARM EKİPMANLARI FD8060</p>	 <p>YANGIN ALARM SİSTEMLERİ S.61 KONVANSİYONEL YANGIN ALARM EKİPMANLARI FD8040</p>	 <p>YANGIN ALARM SİSTEMLERİ S.65 KONVANSİYONEL YANGIN ALARM EKİPMANLARI FD3050</p>	 <p>YANGIN ALARM SİSTEMLERİ S.65 KONVANSİYONEL YANGIN ALARM EKİPMANLARI DB8000</p>	 <p>YANGIN ALARM SİSTEMLERİ S.65 KONVANSİYONEL YANGIN ALARM EKİPMANLARI DB8000R</p>
 <p>YANGIN ALARM SİSTEMLERİ S.66 ACİL YÖNLENDİRME SİRENLER SV 2002F</p>	 <p>YANGIN ALARM SİSTEMLERİ S.66 KONVANSİYONEL SİRENLER SB 112F</p>	 <p>YANGIN ALARM SİSTEMLERİ S.66 KONVANSİYONEL AKSESUARLAR Rİ31</p>	 <p>YANGIN ALARM SİSTEMLERİ S.66 KONVANSİYONEL AKSESUARLAR Rİ31S</p>	 <p>YANGIN ALARM SİSTEMLERİ S.67 KONVANSİYONEL AKSESUARLAR YKB02K</p>	 <p>YANGIN ALARM SİSTEMLERİ S.67 KONVANSİYONEL AKSESUARLAR YKB02A</p>	 <p>YANGIN ALARM SİSTEMLERİ S.67 KONVANSİYONEL AKSESUARLAR YAZILIM</p>
 <p>YANGIN ALARM SİSTEMLERİ S.67 KONVANSİYONEL AKSESUARLAR AKV01 AKÜ</p>	 <p>YANGIN ALARM SİSTEMLERİ S.67 KONVANSİYONEL AKSESUARLAR AKV02 AKÜ</p>	 <p>ACİL AYDINLATMA ve ACİL YÖNLENDİRME S.68 17120-265mm LED'li</p>	 <p>ACİL AYDINLATMA ve ACİL YÖNLENDİRME S.68 17120-265mm LED'li ÖZEL</p>	 <p>ACİL AYDINLATMA ve ACİL YÖNLENDİRME S.68 17110-265mm LED'li</p>	 <p>ACİL AYDINLATMA ve ACİL YÖNLENDİRME S.68 17110-265mm LED'li ÖZEL</p>	 <p>ACİL AYDINLATMA ve ACİL YÖNLENDİRME S.68 17120-305mm LED'li</p>
 <p>ACİL AYDINLATMA ve ACİL YÖNLENDİRME S.68 17120-305mm LED'li ÖZEL</p>	 <p>ACİL AYDINLATMA ve ACİL YÖNLENDİRME S.68 17110-305mm LED'li</p>	 <p>ACİL AYDINLATMA ve ACİL YÖNLENDİRME S.68 17110-305mm LED'li ÖZEL</p>	 <p>ACİL AYDINLATMA ve ACİL YÖNLENDİRME S.69 15036 36 LED'li</p>	 <p>ACİL AYDINLATMA ve ACİL YÖNLENDİRME S.69 15036 36 LED'li / ÖZEL</p>	 <p>ACİL AYDINLATMA ve ACİL YÖNLENDİRME S.69 16036 36 LED'li</p>	 <p>ACİL AYDINLATMA ve ACİL YÖNLENDİRME S.69 16036 36 LED'li / ÖZEL</p>
 <p>ACİL AYDINLATMA ve ACİL YÖNLENDİRME S.70 15136 36 LED'li</p>	 <p>ACİL AYDINLATMA ve ACİL YÖNLENDİRME S.70 15136 36 LED'li / ÖZEL</p>	 <p>ACİL AYDINLATMA ve ACİL YÖNLENDİRME S.70 16136 36 LED'li</p>	 <p>ACİL AYDINLATMA ve ACİL YÖNLENDİRME S.70 16136 36 LED'li / ÖZEL</p>	 <p>ACİL AYDINLATMA ve ACİL YÖNLENDİRME S.71 15036 48 LED'li</p>	 <p>ACİL AYDINLATMA ve ACİL YÖNLENDİRME S.71 15036 48 LED'li / ÖZEL</p>	 <p>ACİL AYDINLATMA ve ACİL YÖNLENDİRME S.71 16036 48 LED'li</p>
 <p>ACİL AYDINLATMA ve ACİL YÖNLENDİRME S.71 16036 48 LED'li / ÖZEL</p>	 <p>ACİL AYDINLATMA ve ACİL YÖNLENDİRME S.72 15136 48 LED'li</p>	 <p>ACİL AYDINLATMA ve ACİL YÖNLENDİRME S.72 15136 48 LED'li / ÖZEL</p>	 <p>ACİL AYDINLATMA ve ACİL YÖNLENDİRME S.72 16136 48 LED'li</p>	 <p>ACİL AYDINLATMA ve ACİL YÖNLENDİRME S.72 16136 48 LED'li / ÖZEL</p>	 <p>ACİL AYDINLATMA ve ACİL YÖNLENDİRME S.73 20024 24 LED'li</p>	 <p>ACİL AYDINLATMA ve ACİL YÖNLENDİRME S.73 20024 24 LED'li / ÖZEL</p>
 <p>ACİL AYDINLATMA ve ACİL YÖNLENDİRME S.73 20124 24 LED'li</p>	 <p>ACİL AYDINLATMA ve ACİL YÖNLENDİRME S.73 20124 24 LED'li / ÖZEL</p>	 <p>ACİL AYDINLATMA ve ACİL YÖNLENDİRME S.74 20024 48 LED'li</p>	 <p>ACİL AYDINLATMA ve ACİL YÖNLENDİRME S.74 20024 48 LED'li / ÖZEL</p>	 <p>ACİL AYDINLATMA ve ACİL YÖNLENDİRME S.74 20124 48 LED'li</p>	 <p>ACİL AYDINLATMA ve ACİL YÖNLENDİRME S.74 20124 48 LED'li / ÖZEL</p>	 <p>ACİL AYDINLATMA ve ACİL YÖNLENDİRME S.75 17000</p>
 <p>ACİL AYDINLATMA ve ACİL YÖNLENDİRME S.75 17001</p>	 <p>ACİL AYDINLATMA ve ACİL YÖNLENDİRME S.75 17002</p>	 <p>ACİL AYDINLATMA ve ACİL YÖNLENDİRME S.75 19141</p>	 <p>ACİL AYDINLATMA ve ACİL YÖNLENDİRME S.76 19145</p>	 <p>ACİL AYDINLATMA ve ACİL YÖNLENDİRME S.76 19145</p>		

LED AYDINLATMA SİSTEMLERİ

ANCHALIGHTING®

					
CAPELLA S.79 HD009 3" LED DOWNLIGHT	CAPELLA S.80 HD012 4" LED DOWNLIGHT	CAPELLA S.81 HD015 5" LED DOWNLIGHT	CAPELLA S.82 HD018 6" LED DOWNLIGHT	CAPELLA S.83 HD024 8" LED DOWNLIGHT	CAPELLA S.84 SD003 LED DOWNLIGHT
					
CAPELLA S.85 SD006 LED DOWNLIGHT	CAPELLA S.86 SD009 LED DOWNLIGHT	CAPELLA S.87 SD012 LED DOWNLIGHT	CAPELLA S.88 SD015 LED DOWNLIGHT	CAPELLA S.89 SD018 LED DOWNLIGHT	CAPELLA S.90 MINI 4" LED DOWNLIGHT
					
CAPELLA S.91 MIDI 6" LED DOWNLIGHT	CAPELLA S.92 MAXI 7" LED DOWNLIGHT	MEISSA S.94 30x30 SIVA ALTI BACKLIGHT LED PANEL	MEISSA S.95 30x30 SIVA ÜSTÜ LED PANEL	MEISSA S.96 30x30 SIVA ALTI CLIP-IN BACKLIGHT LED PANEL	MEISSA S.97 60x60 SIVA ÜSTÜ LED PANEL
					
MEISSA S.98 60x60 SIVA ALTI BACKLIGHT LED PANEL	MEISSA S.99 60x60 SIVA ALTI CLIP-IN BACKLIGHT LED PANEL	ASTERION S.101 30x30 SLIM LED PANEL	ASTERION S.102 30x60 SLIM LED PANEL	ASTERION S.103 30x120 SLIM LED PANEL	ASTERION S.104 60x60 SLIM LED PANEL
					
ASTERION S.105 60x60 SLIM LED PANEL SIVA ÜSTÜ ÇEVİRİCİ	LINA S.107 POWER SIVA ÜSTÜ LINEER SERİSİ	LINA S.108 PURE SIVA ÜSTÜ SLIM LINEER SERİSİ	LINA S.109 PURE SIVA ALTI SLIM LINEER SERİSİ	LINATRUNK S.110 KESİNTİSİZ LINEER AYDINLATMA SİSTEMİ	SITULA ETANJ ARMATÜR ENDÜSTRİYEL ARMATÖRLER S.111
					
SITULA AÇIL AYDINLATMALI ETANJ ARMATÜR ENDÜSTRİYEL ARMATÖRLER S.112	SITULA HF RADAR SENSÖRLÜ ETANJ ARMATÜR ENDÜSTRİYEL ARMATÖRLER S.113	SITULA HF RADAR SENSÖRLÜ VE AÇIL AYDINLATMALI ETANJ ARMATÜR ENDÜSTRİYEL ARMATÖRLER S.114	GRASIAS 10 S.115 MİMARİ VE PEYZAJ AYDINLATMA ARMATÖRLERİ	GRASIAS 30 S.116 MİMARİ VE PEYZAJ AYDINLATMA ARMATÖRLERİ	GRASIAS 50 S.117 MİMARİ VE PEYZAJ AYDINLATMA ARMATÖRLERİ
					
GRASIAS 100 S.118 MİMARİ VE PEYZAJ AYDINLATMA ARMATÖRLERİ	AYDINLATMA ARMATÜRÜ S.119 TA 10220	AYDINLATMA ARMATÜRÜ S.119 TA 10220 KROM	AYDINLATMA ARMATÜRÜ S.120 TA 10330	AYDINLATMA ARMATÜRÜ S.120 TA 10330 KROM	AYDINLATMA ARMATÜRÜ S.121 TA 10430
					
AYDINLATMA ARMATÜRÜ S.121 TA 10430 KROM	AYDINLATMA ARMATÜRÜ S.122 TA 10400	AYDINLATMA ARMATÜRÜ S.122 TA 10400 GÜMÜŞ GRİ	AYDINLATMA ARMATÜRÜ S.123 10955	DUVAR TİPİ AYDINLATMA ARMATÜRÜ S.124 10805	

INDEX

SENSÖR VE SENSÖRLÜ AYDINLATMA SİSTEMLERİ

 <p>HF SENSÖRLÜ LED ARMATÜR S.126 15W 10970</p>	 <p>HF SENSÖRLÜ LED ARMATÜR S.127 15W 10971</p>	 <p>LED ARMATÜR S.128 15W 10972</p>	 <p>LED ARMATÜR S.129 15W 10973</p>	 <p>360° HAREKET SENSÖRLÜ LED'Lİ TAVAN ARMATÜRÜ S.130 12W 01000</p>	 <p>360° HAREKET SENSÖRLÜ LED'Lİ TAVAN ARMATÜRÜ S.131 12W 01000 KROM</p>	 <p>360° HAREKET SENSÖRLÜ LED'Lİ TAVAN ARMATÜRÜ S.132 12W 01051</p>	 <p>360° HAREKET SENSÖRLÜ LED'Lİ TAVAN ARMATÜRÜ S.133 12W 01051 KROM</p>	 <p>360° HAREKET SENSÖRLÜ LED'Lİ TAVAN ARMATÜRÜ S.134 12W 00333</p>
 <p>360° HAREKET SENSÖRLÜ LED'Lİ ACİL AYDINLATMALI TAVAN ARMATÜRÜ S.135 12W - 00333.01</p>	 <p>360° HAREKET SENSÖRLÜ LED'Lİ TAVAN ARMATÜRÜ S.136 18W 10551</p>	 <p>360° HAREKET SENSÖRLÜ LED'Lİ TAVAN ARMATÜRÜ S.137 18W 10551 KROM</p>	 <p>360° HAREKET SENSÖRLÜ LED'Lİ ACİL AYDINLATMALI TAVAN ARMATÜRÜ S.138 18W - 10651</p>	 <p>360° HAREKET SENSÖRLÜ LED'Lİ ACİL AYDINLATMALI TAVAN ARMATÜRÜ S.139 18W - 10651 KROM</p>	 <p>360° HAREKET SENSÖRLÜ LED'Lİ TAVAN ARMATÜRÜ S.140 18W 10433</p>	 <p>360° HAREKET SENSÖRLÜ LED'Lİ TAVAN ARMATÜRÜ S.141 18W 10433 KROM</p>	 <p>360° HAREKET SENSÖRLÜ LED'Lİ ACİL AYDINLATMALI TAVAN ARMATÜRÜ S.142 18W - 10434</p>	 <p>360° HAREKET SENSÖRLÜ LED'Lİ ACİL AYDINLATMALI TAVAN ARMATÜRÜ S.143 18W - 10434 KROM</p>
 <p>360° HAREKET SENSÖRLÜ LED'Lİ TAVAN ARMATÜRÜ S.144 18W 10431</p>	 <p>360° HAREKET SENSÖRLÜ LED'Lİ TAVAN ARMATÜRÜ S.145 18W 10431 KROM</p>	 <p>360° HAREKET SENSÖRLÜ LED'Lİ ACİL AYDINLATMALI TAVAN ARMATÜRÜ S.146 18W - 10432</p>	 <p>360° HAREKET SENSÖRLÜ LED'Lİ ACİL AYDINLATMALI TAVAN ARMATÜRÜ S.147 18W - 10432 KROM</p>	 <p>HF (RADAR) SENSÖRLÜ LED'Lİ ACİL AYDINLATMALI TAVAN ARMATÜRÜ S.148 18W - 10951</p>	 <p>HF (RADAR) SENSÖRLÜ LED'Lİ TAVAN ARMATÜRÜ S.149 18W 10952</p>	 <p>HF (RADAR) SENSÖRLÜ TAVAN ARMATÜRÜ S.150 10950</p>	 <p>360° HAREKET SENSÖRLÜ LED'Lİ ACİL AYDINLATMALI TAVAN ARMATÜRÜ S.151 15W - 10710</p>	 <p>360° HAREKET SENSÖRLÜ LED'Lİ ACİL AYDINLATMALI TAVAN ARMATÜRÜ S.152 15W - 10710 GRİ</p>
 <p>360° HAREKET SENSÖRLÜ LED'Lİ ACİL AYDINLATMALI TAVAN ARMATÜRÜ S.153 15W - 10720</p>	 <p>360° HAREKET SENSÖRLÜ LED'Lİ ACİL AYDINLATMALI TAVAN ARMATÜRÜ S.154 15W - 10720 GRİ</p>	 <p>360° HAREKET SENSÖRLÜ LED'Lİ TAVAN ARMATÜRÜ S.155 18W 10410</p>	 <p>360° HAREKET SENSÖRLÜ LED'Lİ TAVAN ARMATÜRÜ S.156 18W 10410 GRİ</p>	 <p>360° HAREKET SENSÖRLÜ ACİL AYDINLATMALI TAVAN ARMATÜRÜ S.157 10700</p>	 <p>360° HAREKET SENSÖRLÜ ACİL AYDINLATMALI TAVAN ARMATÜRÜ S.158 10700 GRİ</p>	 <p>360° HAREKET SENSÖRLÜ TAVAN ARMATÜRÜ S.159 10400</p>	 <p>360° HAREKET SENSÖRLÜ TAVAN ARMATÜRÜ S.160 10400 GRİ</p>	 <p>180° 3 HAREKET SENSÖRLÜ LED'Lİ DUVAR ARMATÜRÜ S.161 10W - 10820</p>
 <p>180° 3 HAREKET SENSÖRLÜ ACİL AYDINLATMALI LED'Lİ DUVAR ARMATÜRÜ S.162 10W - 10840</p>	 <p>180° 3 HAREKET SENSÖRLÜ DUVAR ARMATÜRÜ S.163 10800</p>	 <p>110° HAREKET SENSÖRLÜ LED'Lİ DUVAR ARMATÜRÜ S.164 10201</p>	 <p>110° HAREKET SENSÖRLÜ LED'Lİ DUVAR ARMATÜRÜ S.165 12W - 10211</p>	 <p>360° HAREKET SENSÖRLÜ TAVAN ARMATÜRÜ S.166 00999</p>	 <p>360° HAREKET SENSÖRLÜ TAVAN ARMATÜRÜ S.167 00999 KROM</p>	 <p>360° HAREKET SENSÖRLÜ ACİL AYDINLATMALI LED'Lİ TAVAN ARMATÜRÜ S.168 00777</p>	 <p>360° HAREKET SENSÖRLÜ ACİL AYDINLATMALI LED'Lİ TAVAN ARMATÜRÜ S.169 00777 KROM</p>	 <p>360° HAREKET SENSÖRLÜ TAVAN ARMATÜRÜ S.170 10330</p>
 <p>360° HAREKET SENSÖRLÜ TAVAN ARMATÜRÜ S.171 10330 KROM</p>	 <p>360° HAREKET SENSÖRLÜ TAVAN ARMATÜRÜ S.172 10430</p>	 <p>360° HAREKET SENSÖRLÜ TAVAN ARMATÜRÜ S.173 10430 KROM</p>	 <p>360° TAVAN TIPI TRİO SENSÖR VARLIK SENSÖRÜ S.174 10500</p>	 <p>360° TAVAN TIPI HAREKET SENSÖRÜ S.175 10463</p>	 <p>360° TAVAN TIPI HAREKET SENSÖRÜ S.175 10465</p>	 <p>360° TAVAN TIPI HAREKET SENSÖRÜ S.176 10464</p>	 <p>360° TAVAN TIPI HAREKET SENSÖRÜ S.176 10466</p>	 <p>360° TAVAN TIPI HAREKET SENSÖRÜ (KORİDOR SENSÖR) S.177 10467</p>
 <p>360° TAVAN TIPI HAREKET SENSÖRÜ (KORİDOR SENSÖR) S.177 10468</p>	 <p>360° TAVAN TIPI HAREKET SENSÖRÜ S.178 10360</p>	 <p>360° TAVAN TIPI HAREKET SENSÖRÜ S.178 10359</p>	 <p>360° HAREKET SENSÖRÜ S.179 10361</p>	 <p>360° HAREKET SENSÖRÜ S.179 10362</p>	 <p>360° SPOT TIPI HAREKET SENSÖRÜ S.180 10365</p>	 <p>360° SPOT TIPI HAREKET SENSÖRÜ S.180 10366</p>	 <p>TAVAN TIPI HF (RADAR) SENSÖRÜ S.181 10367</p>	 <p>TAVAN TIPI HF (RADAR) SENSÖRÜ S.181 10901</p>
 <p>DUVAR TIPI HF (RADAR) SENSÖRÜ S.182 10912</p>	 <p>SWITCH TIPI HAREKET SENSÖRÜ S.183 10100</p>	 <p>SWITCH TIPI HAREKET SENSÖRÜ S.183 10100 GRİ</p>	 <p>180° DUVAR TIPI HAREKET SENSÖRÜ S.184 10180</p>	 <p>LED SÜRÜCÜLER S.185 SABİT AKIM LED SÜRÜCÜLER</p>				



INTERKOM SİSTEMLERİ

na·De®

INTERKOM SİSTEMLERİ

YANGIN ALGILAMA ve ACIL AYDINLATMA &
YÖNLENDİRME SİSTEMLERİ

LED AYDINLATMA SİSTEMLERİ

SENSÖR ve SENSÖRLÜ
AYDINLATMA SİSTEMLERİ

V-8

INTERKOM SİSTEMLERİ

V-8

INTERKOM SİSTEMLERİ

N2307ADT-8

7" RENKLİ GÖRÜNTÜLÜ DİAFON



- 7" Yüksek Çözünürlüklü LCD Ekran
- Hızlı Algılama Özelliğine Sahip Dokunmatik Tuşlar
- Eller Serbest (Handsfree) Konuşma
- Kullanıcı Dostu Arayüz
- Daireler Arasında Görüşme Yapabilme Özelliği
- Kapı Otomatığı Kontrolü
- Dış Kapı Paneli ve Haricen İstenilen CCTV Kamerayı Görüntüleyebilme
- Ayarlanabilen Parlaklık, Zıtlık, Renk ve Ses
- Güvenlik ile Görüşebilme
- Rahatsız Etmeyin Özelliği
- İlave Monitör Bağlayabilme
- 12 Polifonik Zil Sesi Seçenekleri
- Gelişmiş OSD Menü
- İsteğe Bağlı Farklı Dil Seçenekleri

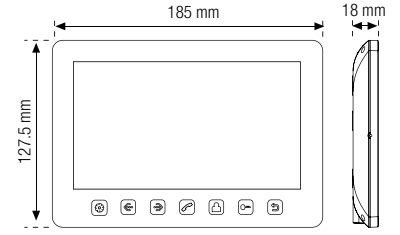

690,00 TL

Çalışma Gerilimi 15 VDC	Monitör 7" Renkli	Güvenlik Güvenlik
Zil Paneli + CCTV	Kapı Otomatığı	OSD Ayarlar
Panel Görüntüleme	Daireler Arası Görüşme	Gizli Görüşme
Çalışma Sıcaklığı 0°C ~ +50°C	2 YEARS GUARANTY	CE

N2804ADT-8

4,3" RENKLİ GÖRÜNTÜLÜ DİAFON

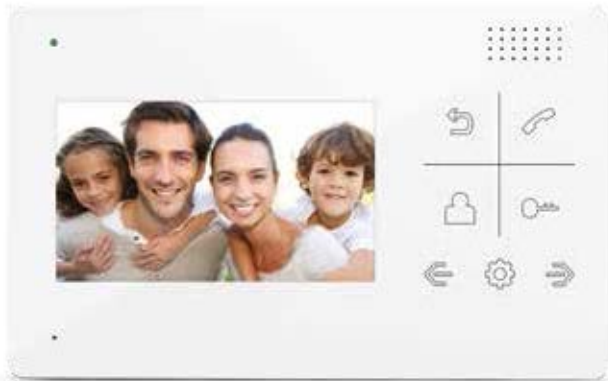

- 4.3" Yüksek Çözünürlüklü LCD Ekran
- Hızlı Algılama Özelliğine Sahip Dokunmatik Tuşlar
- Eller Serbest (Handsfree) Konuşma
- Kullanıcı Dostu Arayüz
- Daireler Arasında Görüşme Yapabilme Özelliği
- Kapı Otomatığı Kontrolü
- Dış Kapı Paneli Ve Haricen İstenilen CCTV Kamerayı Görüntüleyebilme Özelliği
- Ayarlanabilen Parlaklık, Zıtlık, Renk ve Ses
- Güvenlikle Görüşebilme Özelliği
- Rahatsız Etmeyin Özelliği
- İlave Monitör Bağlama Seçeneği
- 25 Polifonik Zil Sesi Seçenekleri
- Gelişmiş OSD Menü
- İsteğe Bağlı Farklı Dil Seçenekleri

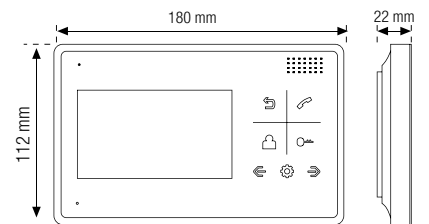

430,00 TL

Çalışma Gerilimi 14.5 VDC	Monitör 4,3" Renkli	Güvenlik Güvenlik
Zil Paneli + CCTV	Kapı Otomatığı	OSD Ayarlar
Panel Görüntüleme	Daireler Arası Görüşme	Çalışma Sıcaklığı 0°C ~ +40°C
	2 YEARS GUARANTY	CE

V-8

INTERKOM SİSTEMLERİ

N28AC

DİJİTAL KAMERALI ZİL PANELLERİ

- Grafik Ekranı ile Kolay Kullanım
- Arka Aydınlatmalı Butonlar
- Alüminyum Alaşımli Döküm Panel
- Bütün Daireler için Tanımlanabilen İsim Kaydı ve Özel Şifre Oluşturma
- Güvenlik, Sosyal Tesisler ve Kapıcı ile Görüşme Özelliği
- Diğer Binalardaki Daireler ile Görüşme Özelliği



1.560,00 TL

Çalışma Gerilimi 18-36V	Kamera Renkli	Kapı Otomatlığı
Ayarlar	Çalışma Sıcaklığı -25°C ~ +50°C	Koruma Derecesi IP 54 II Sınıf

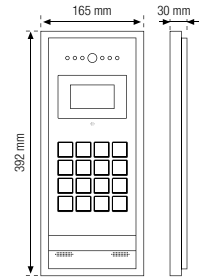

N28BC

DİJİTAL KAMERALI, RF-ID KARTLI ZİL PANELİ

- Kart Okuyucu Özelliğiyle Ekran Şifreli ve Kartlı Geçiş Özelliği
- Grafik Ekranı ile Kolay Kullanım
- Arka Aydınlatmalı Butonlar
- Alüminyum Alaşımli Döküm Panel
- Bütün Daireler için Tanımlanabilen İsim Kaydı ve Özel Şifre Oluşturma,
- Güvenlik, Sosyal Tesisler ve Kapıcı ile Görüşme Özelliği
- Diğer Binalardaki Daireler ile Görüşme Özelliği



1.800,00 TL

Çalışma Gerilimi 18-36V	Kamera Renkli	Kapı Otomatlığı
Ayarlar	Çalışma Sıcaklığı -25°C ~ +50°C	Koruma Derecesi IP 54 II Sınıf

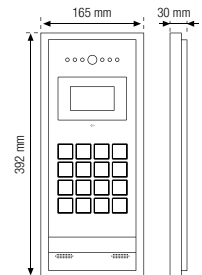

V-8

INTERKOM SİSTEMLERİ

N1607BCR

GÜVENLİK TELEFONU



- 7" Yüksek Çözünürlüklü LCD Ekran
- Kullanıcı Dostu Arayüz
- Daire İçi Monitörlerle Görüşme Yapabilme Özelliği
- Otomatik Mesaj Bırakabilme Özelliği
- Dış Kapı Paneli ve Haricen İstenilen CCTV Kamerayı Görüntüleyebilme
- Ayarlanabilen Parlaklık, Zıtlık, Renk ve Ses

- Hareket Algılama Özelliği Taşıyan DVR Fonksiyonu
- Ses, Fotoğraf ve Video Kaydetme
- Dahili Hafıza/SD Kart'a Kayıt Yapabilme Özelliği
- Gelişmiş Multimedia Özelliği ile Çekilen Fotoğrafları Görüntüleme ve Müzik Oynatma
- Daire Sakinlerini İçeren Liste Kaydı ve Görüntülenmesi
- Takvim ve Alarm Verebilme Özelliği
- İsteğe Bağlı Farklı Dil Seçenekleri

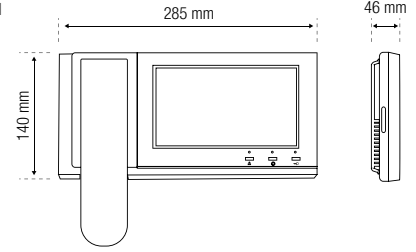

1.080,00 TL



NV03

DAĞITICI

- Her Biri 50 Daireyi Besleyen 6 Adet Hat Çıkışı
- Toplam 200 Daire kapasiteli
- 2 Adet CCTV Girişi
- Güvenlik Telefonu Bağlantı Girişi
- 2 Adet Panel Girişi



460,00 TL



PW01.1

GÜÇ KAYNAĞI

- Çıkış Gücü : 90W
- Çıkış Voltajı : 36V 2A (Anlık 2.5A)
- Batarya Şarj Çıkışı : 27.6V / 0.5A



140,00 TL



V-8

INTERKOM SİSTEMLERİ

PAKET FİYAT TABLOSU



	N2307ADT-8 - 7\"	N2804ADT-8 - 4,3\"
DAİRE SAYISI	FİYAT (TL)	FİYAT (TL)
1	2.850,00	2.590,00
2	3.540,00	3.020,00
3	4.230,00	3.450,00
4	4.920,00	3.880,00
5	5.610,00	4.310,00
6	6.300,00	4.740,00
7	6.990,00	5.170,00
8	7.680,00	5.600,00
9	8.370,00	6.030,00
10	9.060,00	6.460,00
11	9.750,00	6.890,00
12	10.440,00	7.320,00
13	11.130,00	7.750,00
14	11.820,00	8.180,00
15	12.510,00	8.610,00
16	13.200,00	9.040,00
17	13.890,00	9.470,00
18	14.580,00	9.900,00
19	15.270,00	10.330,00
20	15.960,00	10.760,00
21	16.650,00	11.190,00
22	17.340,00	11.620,00
23	18.030,00	12.050,00
24	18.720,00	12.480,00
25	19.410,00	12.910,00
Görüntülü Kapıcı Telefonu Farkı	690,00	430,00

Tablodaki fiyatlara tesisat ek ürünleri eklenmemiş olup, fiyatlar; monitör, zil panelli, dağıtıcı ve güç kaynağı olarak hazırlanmıştır.

**** V-8 sistemlerinde ek tesisat ürünleri aşağıdaki açıklamalara göre verilmelidir.**

- V-8 sistemin kablolama alt yapısı daireden daireye olması önerilir. Eğer şaftlı sistem kullanılacak ise 1 kolon hattına maksimum 12 daire bağlanmalıdır.
- Kapıcı telefonu tercihe göre farklılık gösterebilir (N2307ADT-8 - N2804ADT-8).
- M1607BCR güvenlik telefonu ile dağıtıcı arasındaki mesafe en fazla 100 m olmalıdır.
- Güvenlik telefonunda kullanılacak kablo CAT6 olmalıdır.
- Güvenlik telefonu ilave edildiğinde RJ-45 bağlantı soketi kullanılmamalıdır.
- Blok sayısı arttıkça bu oranda NH01 yatay dağıtıcı kullanılmalıdır.

PW01.1 Güç Kaynağı Farkı

- Güç kaynağı kapasitesi aşağıdaki tabloda verilmiştir.
- Kapasite aşıldığı durumda PW01.1 ürünü ilave olarak verilmelidir.

KABLO ÇEŞİDİ	MAX MOTİNÖR
DT8 - CAT6	40 Monitör

V-BUS9

INTERKOM SİSTEMLERİ

INTERKOM SİSTEMLERİ

YANGIN ALGILAMA ve ACIL AYDINLATMA &
YÖNLENDİRME SİSTEMLERİ

LED AYDINLATMA SİSTEMLERİ

SENSÖR ve SENSÖRLÜ
AYDINLATMA SİSTEMLERİ

V-BUS9

INTERKOM SİSTEMLERİ

N2307ADT

7" RENKLİ GÖRÜNTÜLÜ DİAFON



- 7" Yüksek Çözünürlüklü Lcd Ekran
- Hızlı Algılama Özelliğine Sahip Dokunmatik Tuşlar
- Eller Serbest (Handsfree) Konuşma
- Kullanıcı Dostu Arayüz
- Daireler Arasında Görüşme Yapabilme Özelliği
- Kapı Otomatığı Kontrolü
- Dış Kapı Paneli Ve Haricen İstenilen CCTV Kamerayı Görüntüleyebilme Özelliği
- Ayarlanabilen Parlaklık, Zıtlık, Renk ve Ses
- Güvenlikle Görüşebilme Özelliği
- Rahatsız Etmeyin Özelliği
- İlave Monitör Bağlama Seçeneği
- 12 Polifonik Zil Sesi Seçeneği
- Gelişmiş OSD Menü
- İsteğe Bağlı Farklı Dil Seçenekleri

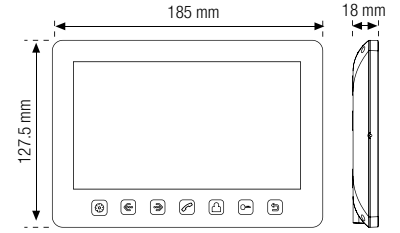

690,00 TL

Çalışma Gerilimi 15 VDC	Monitör 7" Renkli	Güvenlik Güvenlik
Zil Paneli + CCTV	Kapı Otomatığı	OSD Ayarlar
Panel Görüntüleme	Daireler Arası Görüşme	Gizli Görüşme
Çalışma Sıcaklığı 0°C ~ +50°C	2 YEARS GUARANTY	CE

N280ADT

4,3" RENKLİ GÖRÜNTÜLÜ DİAFON



- 4.3" Yüksek Çözünürlüklü Lcd Ekran
- Hızlı Algılama Özelliğine Sahip Dokunmatik Tuşlar
- Eller Serbest (Handsfree) Konuşma Özelliği
- Kullanıcı Dostu Arayüz
- Daireler Arasında Görüşme Yapabilme Özelliğine Sahip
- Kapı Otomatığı Kontrolü
- Dış Kapı Paneli Ve Haricen İstenilen CCTV Kamerayı Görüntüleyebilme Özelliği
- Ayarlanabilen Parlaklık, Zıtlık, Renk ve Ses
- Güvenlikle Görüşebilme Özelliği
- Rahatsız Etmeyin Özelliği
- İlave Monitör Bağlama Seçeneği
- 25 Polifonik Zil Sesi Seçeneği
- Gelişmiş OSD Menü
- İsteğe Bağlı Farklı Dil Seçenekleri

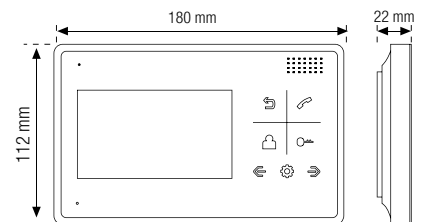

430,00 TL

Çalışma Gerilimi 14.5 VDC	Monitör 4,3" Renkli	Güvenlik Güvenlik
Zil Paneli + CCTV	Kapı Otomatığı	OSD Ayarlar
Panel Görüntüleme	Daireler Arası Görüşme	Çalışma Sıcaklığı 0°C ~ +40°C
	2 YEARS GUARANTY	CE

V-BUS9

INTERKOM SİSTEMLERİ

N28AC

DİĞİTAL KAMERALI ZİL PANELLERİ

- Grafik Ekranı ile Kolay Kullanım
- Arka Aydınlatmalı Butonlar
- Alüminyum Alaşımli Döküm Panel
- Bütün Daireler için Tanımlanabilen İsim Kaydı ve Özel Şifre Oluşturma
- Güvenlik, Sosyal Tesisler ve Kapıcı ile Görüşme Özelliği
- Diğer Binalardaki Daireler ile Görüşme Özelliği



1.560,00 TL

Çalışma Gerilimi 18-36V	Kamera Renkli	Kapı Otomatlığı
Ayarlar	Çalışma Sıcaklığı -25°C ~ +50°C	Koruma Derecesi IP 54 II Sınıf

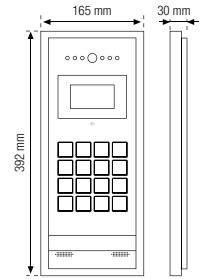

N28BC

DİĞİTAL KAMERALI, RF-ID KARTLI ZİL PANELİ

- Kart Okuyucu Özelliğiyle Ekran Şifreli ve Kartlı Geçiş Özelliği
- Grafik Ekranı ile Kolay Kullanım
- Arka Aydınlatmalı Butonlar
- Alüminyum Alaşımli Döküm Panel
- Bütün Daireler için Tanımlanabilen İsim Kaydı ve Özel Şifre Oluşturabilme
- Güvenlik, Sosyal Tesisler ve Kapıcı ile Görüşme Özellikleri
- Diğer Binalardaki Daireler ile Görüşme Özelliği



1.800,00 TL

Çalışma Gerilimi 18-36V	Kamera Renkli	Kapı Otomatlığı
Ayarlar	Çalışma Sıcaklığı -25°C ~ +50°C	Koruma Derecesi IP 54 II Sınıf

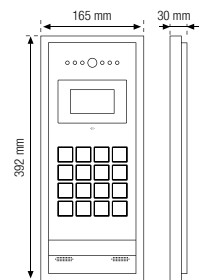

V-BUS9

INTERKOM SİSTEMLERİ

N1607BCR

GÜVENLİK TELEFONU

1.080,00 TL

- 7" Yüksek Çözünürlüklü LCD Ekran
- Kullanıcı Dostu Arayüz
- Daire İçerisindeki Monitörlerle Görüşme Yapabilme Özelliği
- Otomatik Mesaj Bırakabilme Özelliği
- Dış Kapı Paneli Ve Haricen İstenilen CCTV Kamerayı Görüntüleyebilme Özelliği
- Ayarlanabilen Parlaklık, Zıtlık, Renk ve Ses
- Hareket Algılama Özelliği Taşıyan DVR Fonksiyonu
- Ses, Fotoğraf ve Video Kaydetme Özelliği
- Dahili Hafıza/SD Karta Kayıt Yapabilme Özelliği
- Gelişmiş Multimedya Özelliği ile Çekilen Fotoğrafları Görüntüleme ve Müzik Oynatma
- Daire Sakinlerini İçeren Liste Kaydı ve Görüntülenmesi
- Takvim ve Alarm Verebilme Özellikleriyle,
- İsteğe Bağlı Farklı Dil Seçeneklerine Sahip

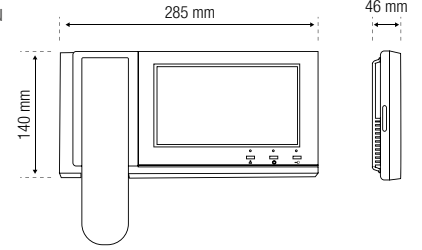

NH01

YATAY DAĞITICI

588,00 TL

- Yatay Dağıtıcılarla Kaskad Bağlanabilme
- 2 Adet Panel Girişli



NH02

YATAY DAĞITICI

660,00 TL

- 4 Adet Panel Girişli



V-BUS9

INTERKOM SİSTEMLERİ

NH03

YATAY DAĞITICI

- 4 Adet CCTV Desteği
- 2 Adet Panel Desteği (NH02 ile 8 Panel)
- Ağ Sinyallerini Dönüştürüp Dağıtabilme Özelliği



588,00 TL



18-36V DC



NV01

DİKEY DAĞITICI

- 4 Adet Monitör Kullanımını Destekler
- Dikey Dağıtıcılarla Kaskad Bağlanabilme Özelliği



280,00 TL



18-36V DC



PW01.1

GÜÇ KAYNAĞI

- Çıkış Gücü: 90W
- Çıkış Voltajı: 36V/2A (Anlık 2,5A)
- Batarya Şarj Çıkışı: 27.6V/0.5A



140,00 TL



100-240V-50-60Hz



NC01

RJ45 BAĞLANTI SOKETİ

- Güvenlik telefonunun ve VBUS9 monitörlerinin dağıtıcıya bağlantısını sağlar.



36,00 TL

V-BUS9

INTERKOM SİSTEMLERİ

PAKET FİYAT TABLOSU



	M2307ADT - 7\"/>	
DAİRE SAYISI	FİYAT (TL)	FİYAT (TL)
1	2.850,00	2.590,00
2	3.540,00	3.020,00
3	4.230,00	3.450,00
4	4.920,00	3.880,00
5	5.610,00	4.310,00
6	6.300,00	4.740,00
7	6.990,00	5.170,00
8	7.680,00	5.600,00
9	8.370,00	6.030,00
10	9.060,00	6.460,00
11	9.750,00	6.890,00
12	10.440,00	7.320,00
13	11.130,00	7.750,00
14	11.820,00	8.180,00
15	12.510,00	8.610,00
16	13.200,00	9.040,00
17	13.890,00	9.470,00
18	14.580,00	9.900,00
19	15.270,00	10.330,00
20	15.960,00	10.760,00
21	16.650,00	11.190,00
22	17.340,00	11.620,00
23	18.030,00	12.050,00
24	18.720,00	12.480,00
25	19.410,00	12.910,00
Görüntülü Kapıcı Telefonu Farkı	690,00	430,00

Tablodaki fiyatlara tesisat ek ürünleri eklenmemiş olup, fiyatlar; monitör, zil paneli, dağıtıcı ve güç kaynağı olarak hazırlanmıştır.

**** V-BUS9 sistemlerinde ek tesisat ürünleri aşağıdaki açıklamalara göre verilmelidir.**

- V-BUS9 sistemin kablolanması şaftlı sistem olmalıdır.
- Kapıcı telefonu tercihe göre farklılık gösterebilir (M2307ADT - M280ADT).
- Güvenlik telefonunda kullanılacak kablo CAT6 olmalıdır.
- N1607BCR güvenlik telefonu ilave edildiğinde RJ-45 bağlantı soketi, NV01 dikey dağıtıcı, PW01.1 güç kaynağı ve NH01 dağıtıcı kullanılmalıdır.
- Blok sayısı arttıkça bu oranda NH01 yatay dağıtıcı kullanılmalıdır.

PW01.1 Güç Kaynağı Farkı

- Güç kaynağı kapasitesi aşağıdaki tabloda verilmiştir.
- Kapasite aşıldığı durumda PW01.1 ürünü ilave olarak verilmelidir.

KABLO ÇEŞİDİ	MAX MOTİNÖR
CAT5 - CAT6	25 Monitör

V-BUS7

INTERKOM SİSTEMLERİ

INTERKOM SİSTEMLERİ

YANGIN ALGILAMA ve ACIL AYDINLATMA &
YÖNLENDİRME SİSTEMLERİ

LED AYDINLATMA SİSTEMLERİ

SENSÖR ve SENSÖRLÜ
AYDINLATMA SİSTEMLERİ

V-BUS7

INTERKOM SİSTEMLERİ

NVM-800MCW (BEYAZ)

7" RENKLİ GÖRÜNTÜLÜ DİAFON



- 7" Yüksek Çözünürlüklü LCD Ekran
- Hızlı Algılama Özelliğine Sahip Dokunmatik Tuşlar
- Eller Serbest (Handsfree) Konuşma
- Kullanıcı Dostu Arayüz
- Kapı Otomatığı Kontrolü
- Merdiven Otomatığı Kontrolü
- Güvenlikle Görüşebilme Özelliği

- Kapıcı ile Görüşebilme Özelliği
- Dış Kapı ve Daire Önü Kamerası Görüntüleme
- 4 Adet CCTV Kamerası Görüntüleyebilme
- Ayarlanabilen Parlaklık, Zıtlık, Renk ve Ses
- Sıva üstü Askı Aparatı ile Kolay Montaj
- 4 Farklı Zil ve Alarm Sesi Seçenekleri
- Daireye Birden Fazla İlave Monitör Bağlayabilme

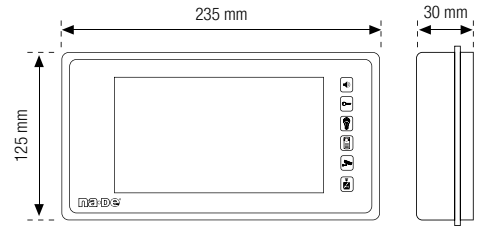
**600,00 TL**

Çalışma Gerilimi Santralden	Monitör 7" Renkli	Merdiven Otomatığı
Panel Görüntüleme	CCTV	Güvenlik Arama
Kapı Otomatığı	Ayarlar	Gizli Görüşme
Çalışma Sıcaklığı -20°C ~ +40°C	Koruma Derecesi IP 20 II Sınıfı	2 YEARS GUARANTY

CE

NVM-800MCB (SİYAH)

7" RENKLİ GÖRÜNTÜLÜ DİAFON



- 7" Yüksek Çözünürlüklü LCD Ekran
- Hızlı Algılama Özelliğine Sahip Dokunmatik Tuşlar
- Eller Serbest (Handsfree) Konuşma
- Kullanıcı Dostu Arayüz
- Kapı Otomatığı Kontrolü
- Merdiven Otomatığı Kontrolü
- Güvenlikle Görüşebilme Özelliği

- Kapıcı ile Görüşebilme Özelliği
- Dış Kapı ve Daire Önü Kamerası Görüntüleme
- 4 Adet CCTV Kamerası Görüntüleyebilme
- Ayarlanabilen Parlaklık, Zıtlık, Renk ve Ses
- Sıva üstü Askı Aparatı ile Kolay Montaj
- 4 Farklı Zil ve Alarm Sesi Seçenekleri
- Daireye Birden Fazla İlave Monitör Bağlayabilme

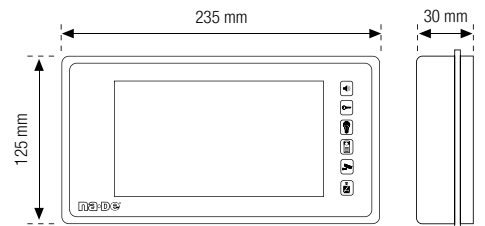
**600,00 TL**

Çalışma Gerilimi Santralden	Monitör 7" Renkli	Merdiven Otomatığı
Panel Görüntüleme	CCTV	Güvenlik Arama
Kapı Otomatığı	Ayarlar	Gizli Görüşme
Çalışma Sıcaklığı -20°C ~ +40°C	Koruma Derecesi IP 20 II Sınıfı	2 YEARS GUARANTY

CE

V-BUS7

INTERKOM SİSTEMLERİ

NVM-430MC

4.3" RENKLİ GÖRÜNTÜLÜ DİAFON



420,00 TL

Çalışma Gerilimi Santraleden	Monitör 7" Renkli	Merdiven Otomatığı
Zil Paneli + CCTV	Kapı Otomatığı	Ayarlar
Gizli Görüşme	Çalışma Sıcaklığı -20°C - +40°C	Koruma Derecesi IP 20 II Sınıf
2 YEARS GUARANTY		CE

- 3.5" Yüksek Çözünürlüklü LCD Ekran
- Eller Serbest (Handsfree) Konuşma Özelliği
- Kullanıcı Dostu Arayüz
- Kapı Otomatığı Kontrolü
- Merdiven Otomatığı Kontrolü
- Güvenlikle Görüşebilme Özelliği
- Kapıcı ile Görüşebilme Özelliği
- Dış Kapı ve Daire Önü Kamerası Görüntüleyebilme
- 4 Adet CCTV Kamerası Görüntüleyebilme
- Ayarlanabilen Parlaklık, Zıtlık, Renk ve Ses
- Sıva üstü Askı Aparatı ile Kolay Montaj
- 4 Farklı Zil ve Alarm Sesi Seçenekleri
- Daireye Birden Fazla İlave Monitör Bağlama Seçeneği

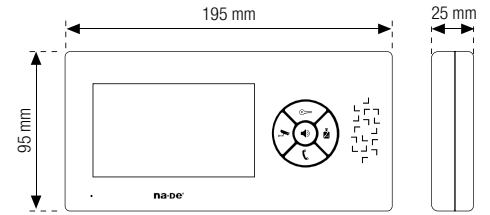

NVM-360MC

3,5" RENKLİ GÖRÜNTÜLÜ DİAFON



400,00 TL

Çalışma Gerilimi Santraleden	Monitör 3.5" Renkli	Merdiven Otomatığı
Güvenlik	Zil Paneli + CCTV	Kapı Otomatığı
Ayarlar	Gizli Görüşme	Çalışma Sıcaklığı -20°C - +40°C
Koruma Derecesi IP 20 II Sınıf	2 YEARS GUARANTY	CE

- 3,5" Yüksek Çözünürlüklü LCD Ekran
- Eller Serbest (Handsfree) Konuşma Özelliği
- Kullanıcı Dostu Arayüz
- Kapı Otomatığı Kontrolü
- Merdiven Otomatığı Kontrolü
- Güvenlikle Görüşebilme Özelliği
- Dış Kapı ve Daire Önü Kamerası Görüntüleyebilme
- Kapıcı ile Görüşebilme Özelliği
- 4 Adet CCTV Kamerası Görüntüleyebilme
- Ayarlanabilen Parlaklık, Zıtlık, Renk ve Ses
- Sıva üstü Askı Aparatı ile Kolay Montaj
- 4 Farklı Zil ve Alarm Sesi Seçenekleri
- Daireye Birden Fazla İlave Monitör Bağlama Seçeneği

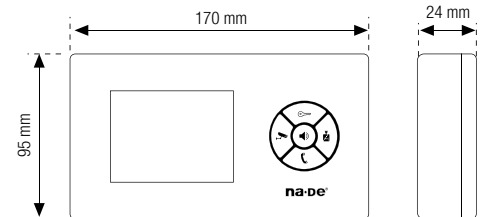

V-BUS7

INTERKOM SİSTEMLERİ

NVM-350MCW (BEYAZ)

3,5" RENKLİ GÖRÜNTÜLÜ DİAFON



- 3.5" Yüksek Çözünürlüklü LCD Ekran
- Eller Serbest (Handsfree) Konuşma
- Dokunmatik Tuş Takımı
- Kullanıcı Dostu Arayüz
- Kapı Otomatığı Kontrolü
- Merdiven Otomatığı Kontrolü
- Güvenlikle Görüşebilme Özelliği
- Kapıcı ile Görüşebilme Özelliği
- Dış Kapı ve Daire Önü Kamerası Görüntüleyebilme
- 4 Adet CCTV Kamerası Görüntüleyebilme
- Ayarlanabilen Parlaklık, Zıtlık, Renk ve Ses
- Sıva üstü Askı Aparatı ile Kolay Montaj
- 4 Farklı Zil ve Alarm Sesi Seçenekleri
- Daireye Birden Fazla İlave Monitör Bağlama Seçeneği

400,00 TL

Çalışma Gerilimi Santralden	Monitör 3.5" Renkli	Merdiven Otomatığı
Güvenlik	Zil Paneli + CCTV	Kapı Otomatığı
Ayarlar	Gizli Görüşme	Çalışma Sıcaklığı -20°C ~ +40°C
Koruma Derecesi IP 20 II Sınıfı	2 YEARS GUARANTEE	CE

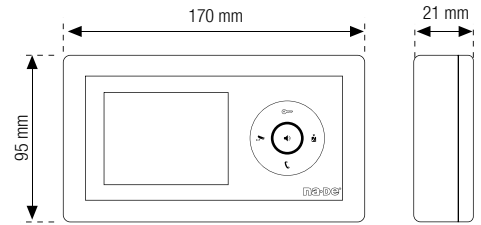
**350MCB (SİYAH)**

3,5" RENKLİ GÖRÜNTÜLÜ DİAFON



- 3.5" Yüksek Çözünürlüklü LCD Ekran
- Eller Serbest (Handsfree) Konuşma
- Dokunmatik Tuş Takımı
- Kullanıcı Dostu Arayüz
- Kapı Otomatığı Kontrolü
- Merdiven Otomatığı Kontrolü
- Güvenlikle Görüşebilme Özelliği
- Kapıcı ile Görüşebilme Özelliği
- Dış Kapı ve Daire Önü Kamerası Görüntüleyebilme
- 4 Adet CCTV Kamerası Görüntüleyebilme
- Ayarlanabilen Parlaklık, Zıtlık, Renk ve Ses
- Sıva üstü Askı Aparatı ile Kolay Montaj
- 4 Farklı Zil ve Alarm Sesi Seçenekleri
- Daireye Birden Fazla İlave Monitör Bağlama Seçeneği

400,00 TL

Çalışma Gerilimi Santralden	Monitör 3.5" Renkli	Merdiven Otomatığı
Güvenlik	Zil Paneli + CCTV	Kapı Otomatığı
Ayarlar	Gizli Görüşme	Çalışma Sıcaklığı -20°C ~ +40°C
Koruma Derecesi IP 20 II Sınıfı	2 YEARS GUARANTEE	CE

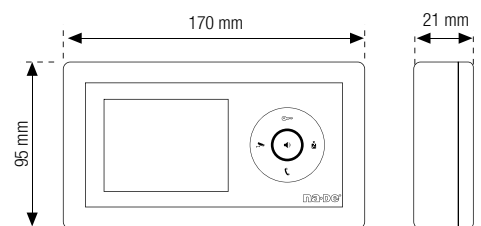

V-BUS7

INTERKOM SİSTEMLERİ

ND-110-8

GÜVENLİK TELEFONU

- Grafik LCD Ekran
- Kapıcı ile Görüşebilme Özelliği
- Daireler ile Görüşebilme Özelliği
- Tarih ve Saat Göstergesi
- Rehber Kaydetme Özelliği
- Rehber Kayıtlı Blok, Daire ve İsim Sorgulama
- 2 Kademeli Melodi Ses Ayarı



1.080,00 TL

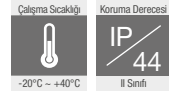

CE

ND-105-7

DAİRE TELEFONU

- Kapı Otomatığı Kontrolü
- Merdiven Otomatığı Kontrolü
- Güvenlikle Görüşebilme Özelliği
- Kapıcı ile Görüşebilme Özelliği
- Ayarlanabilen Zil Sesi
- Sıva üstü Askı Aparatı ile Kolay Montaj
- 4 Farklı Zil Sesi ve Alarm Sesi Seçenekleriyle
- Daireye Birden Fazla İlave Telefon Bağlayabilme
- Telefon Ahizesi Açık Unutulduğunda Sistemin Otomatik Olarak Kapanır



180,00 TL



CE

ND-106-7

KAPICI TELEFONU

- Kapı Otomatığı Kontrolü
- Merdiven Otomatığı Kontrolü
- Güvenlikle Görüşebilme Özelliği
- Ayarlanabilen Zil Sesi
- Sıva üstü Askı Aparatı ile Kolay Montaj
- 4 Farklı Zil Sesi ve Alarm Sesi Seçenekleriyle
- Telefon Ahizesi Açık Unutulduğunda Sistemin Otomatik Olarak Kapanır



180,00 TL



CE

V-BUS7

INTERKOM SİSTEMLERİ

ND-101-8

GÖRÜNTÜLÜ SİSTEM SANTRALİ



- 3 Farklı Kapı Otomatiği
- Merdiven Otomatiği
- Güvenlik ve Kapıcı Bağlayabilme
- Sıva üstü ve Raya Kolay Montaj
- Elektrik Dalgalanmalarından Etkilenmeyen, Kısa Devre Korumalı Güç Katı
- Harici Dedektör Bağlanabilme Özelliği
- Seri Port Üzerinden Bilgisayara Bağlanma

440,00 TL

Çalışma Gerilimi ⚡ 85-265V~(50-60Hz)	Çıkış Gerilimi V +24V DC	Akım A 3,5 A DC
Gizli Görüşme 📞	Çalışma Sıcaklığı 🌡️ -20°C ~ +40°C	Koruma Derecesi IP 20 II Sınıf



ND-101CT-8

CCTV'Lİ GÖRÜNTÜLÜ SİSTEM SANTRALİ



- 3 Farklı Kapı Otomatiği
- Merdiven Otomatiği
- Güvenlik ve Kapıcı Bağlayabilme
- Sıva üstü ve Raya Kolay Montaj
- Elektrik Dalgalanmalarından Etkilenmeyen, Kısa Devre Korumalı Güç Katı
- Harici Dedektör Bağlanabilme Özelliği
- Seri Port Üzerinden Bilgisayara Bağlanma

640,00 TL

Çalışma Gerilimi ⚡ 85-265V~(50-60Hz)	Çıkış Gerilimi V +24V DC	Akım A 3,5 A DC
Gizli Görüşme 📞	Çalışma Sıcaklığı 🌡️ -20°C ~ +40°C	Koruma Derecesi IP 20 II Sınıf



V-BUS7

INTERKOM SİSTEMLERİ

8NDKC

KAMERALI ZİL PANELİ

- Renkli Kamera
- Ayarlanabilen Kamera Açısı
- Kamera Görüşü için LED'li Aydınlatma
- Aydınlatmalı Tuş Takımı
- Grafik LCD
- Sıva Üstü Kolay Montaj
- Rehber Oluşturma, Düzeltme ve Silme Özelliği
- Rehberden İsim Arama
- Şifre Girişi ile Kapı Otomatığı Açma
- Şifreli Yönetim Koruması

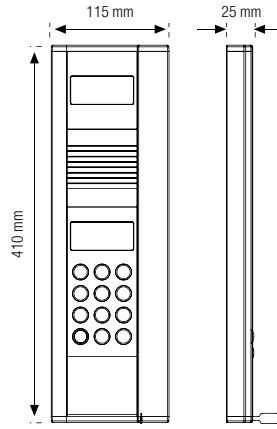

900,00 TL

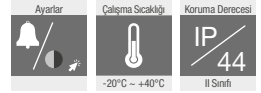
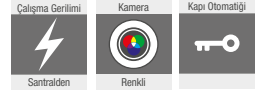

8NDKC-ID

KAMERALI, RF-ID KARTLI ZİL PANELİ

- Renkli Kamera
- Ayarlanabilen Kamera Açısı
- Kamera Görüşü için LED'li Aydınlatma
- Aydınlatmalı Tuş Takımı
- Grafik LCD
- Sıva Üstü Kolay Montaj
- Rehber Oluşturma, Düzeltme ve Silme Özelliği
- Rehberden İsim Arama
- Şifre Girişi ile Kapı Otomatığı Açma
- Şifreli Yönetim Koruması
- RF-ID Kart ile Kapı Otomatığı Açma

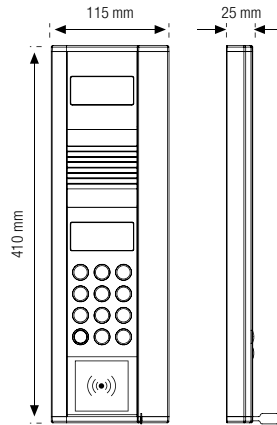

1.050,00 TL

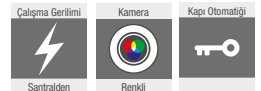

V-BUS7

INTERKOM SİSTEMLERİ

8NDC-XX

BUTONLU TİP RENKLİ KAMERA ZİL PANELİ

- Renkli Kamera
- Ayarlanabilen Kamera Açısı
- Kamera Görüşü için LED'li Aydınlatma
- Sıralı Panellerde En Fazla 52 Adet Buton Guruplanabilir

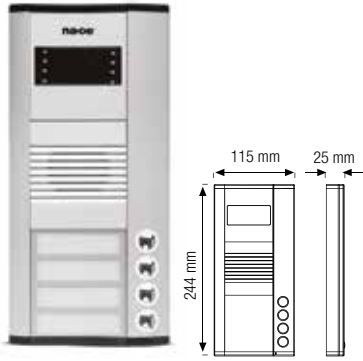

8NDC-244-04

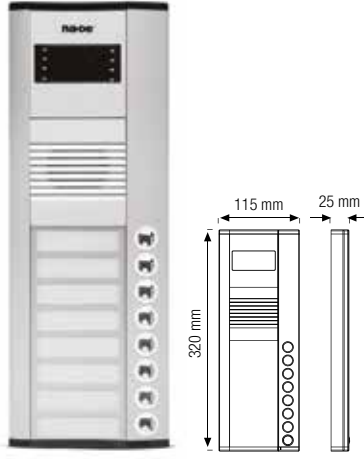

8NDC-320-08

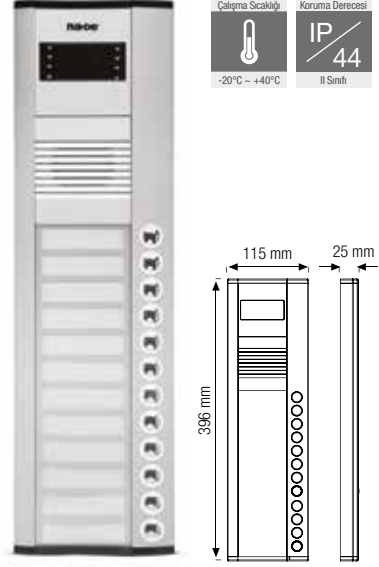

8NDC-396-12

ÜRÜN KOD	BUTON SAYISI	ÖLÇÜSÜ (mm)	FİYAT (TL)
8NDC-244-01	1	244	690,00
8NDC-244-02	2	244	690,00
8NDC-244-03	3	244	690,00
8NDC-244-04	4	244	690,00

ÜRÜN KOD	BUTON SAYISI	ÖLÇÜSÜ (mm)	FİYAT (TL)
8NDC-320-01	1	320	800,00
8NDC-320-02	2	320	800,00
8NDC-320-03	3	320	800,00
8NDC-320-04	4	320	800,00
8NDC-320-05	5	320	800,00
8NDC-320-06	6	320	800,00
8NDC-320-07	7	320	800,00
8NDC-320-08	8	320	800,00

ÜRÜN KOD	BUTON SAYISI	ÖLÇÜSÜ (mm)	FİYAT (TL)
8NDC-396-01	1	396	900,00
8NDC-396-02	2	396	900,00
8NDC-396-03	3	396	900,00
8NDC-396-04	4	396	900,00
8NDC-396-05	5	396	900,00
8NDC-396-06	6	396	900,00
8NDC-396-07	7	396	900,00
8NDC-396-08	8	396	900,00
8NDC-396-09	9	396	900,00
8NDC-396-10	10	396	900,00
8NDC-396-11	11	396	900,00
8NDC-396-12	12	396	900,00

V-BUS7

INTERKOM SİSTEMLERİ

NDKC-IS20 / IS40

ZİL PANELİ İÇİN İSİMLİK

300,00 TL

- 20 Daireli
- Led Aydınlatmalı İsimlik



- 40 Daireli
- Led Aydınlatmalı İsimlik



BUTONLU TİP EK ZİL PANELİ

- Sıva Üstü Kolay Montaj
- LED Aydınlatmalı Buton ve İsimlikler

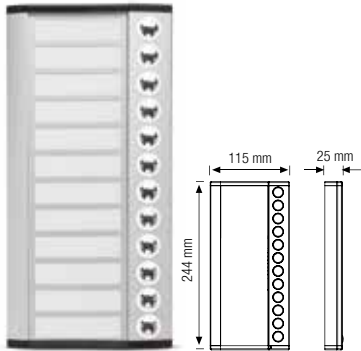

NDEK01-244-12

NDEK02-244-12

270,00 TL

270,00 TL

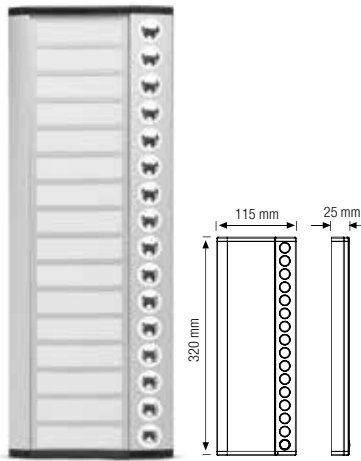

NDEK01-320-16

NDEK02-320-16

300,00 TL

300,00 TL

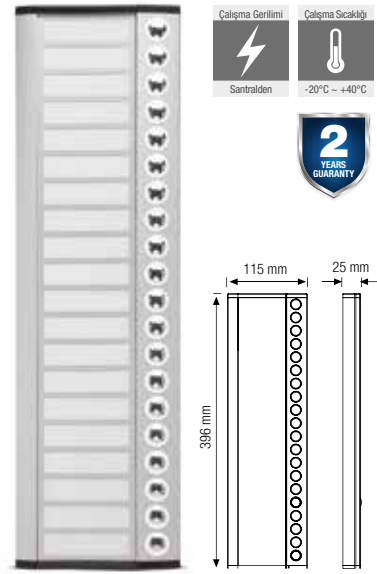

NDEK01-396-20

NDEK01-396-20

350,00 TL

350,00 TL

Çalışma Gerilimi	Çalışma Sıcaklığı	Koruma Derecesi
Santralden	-20°C - +40°C	IP 44
		II Sınıfı



V-BUS7

INTERKOM SİSTEMLERİ

ZİL PANELİ KÖŞE APARATLARI

- 45 Derece
- Kameralı Zil Paneline Uygulanır



NDK-244

150,00 TL

NDK-320

180,00 TL

NDK-396

210,00 TL

NDK-410

240,00 TL

ZİL PANELİ YAĞMURLUK APARATLARI



NDY1-244

180,00 TL

NDY2-244

220,00 TL

NDY1-320

220,00 TL

NDY2-320

250,00 TL

NDY3-320

300,00 TL

- Üstten Gelen Yağmur Damalarına Karşı Korumaya Yararlı Aparat
- Karşıdan ve Sağanak Yağışlarda Korumaya Yararlıdır



NDY1-396

210,00 TL

NDY2-396

300,00 TL

NDY3-396

350,00 TL

NDY1-410

230,00 TL



V-BUS7

INTERKOM SİSTEMLERİ

GK-04-8

200,00 TL

- 24VDC – 3A Güç Kaynağı
- Çalışma Gerilimi: 85-265VAC (50-60Hz)

Çalışma Gerilimi	Çalışma Sıcaklığı	Koruma Derecesi
		
Santralden	-20°C ~ +40°C	II Sınıfı



RF-ID

RF-ID KART

20,00 TL

- RF-ID Kartlı Sistemler için uyumludur



ND-103

VİDEO TOPLAYICI

65,00 TL

- Video Toplayıcı Ünite



Çalışma Gerilimi	Çalışma Sıcaklığı	Koruma Derecesi
		
Santralden	-20°C ~ +40°C	II Sınıfı



ND-104

VİDEO DAĞITICI

45,00 TL

- Video Dağıtıcı Ünite



Çalışma Gerilimi	Çalışma Sıcaklığı	Koruma Derecesi
		
Santralden	-20°C ~ +40°C	II Sınıfı



ND-200

DATA DAĞITICI

75,00 TL

- Data Dağıtıcı Ünite





Çalışma Gerilimi	Çalışma Sıcaklığı	Koruma Derecesi
		
Santralden	-20°C ~ +40°C	II Sınıfı



V-BUS7

INTERKOM SİSTEMLERİ

PAKET FİYAT TABLOSU (8 KABLO)

							
	NVM-430MC 4,3\" RENKLİ	NVM-430MC 4,3\" RENKLİ	NVM-360MC 3,5\" RENKLİ	NVM-360MC 3,5\" RENKLİ	NVM-350MCW 3,5\" RENKLİ-BEYAZ	NVM-350MCW 3,5\" RENKLİ-BEYAZ	
DAİRE SAYISI	FİYAT (TL)	FİYAT (TL)	FİYAT (TL)	FİYAT (TL)	FİYAT (TL)	FİYAT (TL)	
1	1.550,00	1.760,00	1.530,00	1.740,00	1.530,00	1.740,00	
2	1.970,00	2.180,00	1.930,00	2.140,00	1.930,00	2.140,00	
3	2.390,00	2.600,00	2.330,00	2.540,00	2.330,00	2.540,00	
4	2.810,00	3.020,00	2.730,00	2.940,00	2.730,00	2.940,00	
5	3.340,00	3.440,00	3.240,00	3.340,00	3.240,00	3.340,00	
6	3.760,00	3.860,00	3.640,00	3.740,00	3.640,00	3.740,00	
7	4.180,00	4.280,00	4.040,00	4.140,00	4.040,00	4.140,00	
8	4.600,00	4.700,00	4.440,00	4.540,00	4.440,00	4.540,00	
9	5.120,00	5.120,00	4.940,00	4.940,00	4.940,00	4.940,00	
10	5.540,00	5.540,00	5.340,00	5.340,00	4.340,00	5.340,00	
11	5.960,00	5.960,00	5.740,00	5.740,00	5.740,00	5.740,00	
12	6.380,00	6.380,00	6.120,00	6.140,00	6.120,00	6.140,00	
13	6.860,00	6.800,00	6.600,00	6.540,00	6.600,00	6.540,00	
14	7.280,00	7.220,00	7.000,00	6.940,00	7.000,00	6.940,00	
15	7.700,00	7.640,00	7.400,00	7.340,00	7.400,00	7.340,00	
16	8.120,00	8.060,00	7.800,00	7.740,00	7.800,00	7.740,00	
17	8.680,00	8.480,00	8.340,00	8.140,00	8.340,00	8.140,00	
18	9.100,00	8.900,00	8.740,00	8.540,00	8.740,00	8.540,00	
19	9.520,00	9.320,00	9.140,00	8.940,00	9.140,00	8.940,00	
20	9.940,00	9.740,00	9.540,00	9.340,00	9.540,00	9.340,00	
21	10.360,00	10.160,00	10.120,00	9.740,00	10.120,00	9.740,00	
22	10.780,00	10.580,00	10.520,00	10.140,00	10.520,00	10.140,00	
23	11.200,00	11.000,00	10.920,00	10.540,00	10.920,00	10.340,00	
24	11.620,00	11.420,00	11.320,00	10.940,00	11.320,00	10.940,00	
25	12.190,00	11.840,00	11.690,00	11.340,00	11.690,00	11.340,00	
Kapıcı Telefonu Farkı	180,00	180,00	180,00	180,00	180,00	180,00	
Görüntülü Kapıcı Telefonu Farkı	420,00	420,00	400,00	400,00	400,00	400,00	
CCTV Modülü Farkı	200,00	200,00	200,00	200,00	200,00	200,00	

Tablodaki fiyatlara tesisat ek ürünleri eklenmemiş olup, fiyatlar; monitör, sıralı zil paneli, ve santral olarak hazırlanmıştır.

**** V-BUS7 sistemlerinde ek tesisat ürünleri aşağıdaki açıklamalara göre verilmelidir.**

ND-104 Video Dağıtıcı Farkı

- Sisteme buat sayısı kadar ND-104 verilmelidir.
- Santral noktasına birden fazla shaft (kolon) geliyor ise bir adet ND-104 verilmelidir.
- ND-104 ürününde 4 çıkış mevcuttur. Eğer bir buata birden fazla monitör bağlanmış ise dağıtıcı sayısını arttırınız.

ND-200 Data Dağıtıcı Farkı

- Santral noktasından farklı uzaklıklara shaft (kolon) çıkıyor ise bir adet DN-200 ürünü verilmelidir.
- ND-200 data dağıtıcısında 3 çıkış mevcuttur. Yetersiz ise DN-200 sayısını arttırınız.

V-BUS7

INTERKOM SİSTEMLERİ

PAKET FİYAT TABLOSU (8 KABLO)



	NVM-350MCB 3,5" RENKLİ-SİYAH	NVM-350MCB 3,5" RENKLİ-SİYAH	NVM-800MCX 7" RENKLİ-SİYAH	NVM-800MCX 7" RENKLİ-SİYAH	NVM-800MCX 7" RENKLİ-BEYAZ	NVM-800MCX 7" RENKLİ-BEYAZ
	FİYAT (TL)	FİYAT (TL)	FİYAT (TL)	FİYAT (TL)	FİYAT (TL)	FİYAT (TL)
	1.530,00	1.740,00	1.730,00	1.940,00	1.730,00	1.940,00
	1.930,00	2.140,00	2.330,00	2.540,00	2.330,00	2.540,00
	2.330,00	2.540,00	3.930,00	3.140,00	3.930,00	3.140,00
	2.730,00	2.940,00	3.530,00	3.740,00	3.530,00	3.740,00
	3.240,00	3.340,00	4.240,00	4.340,00	4.240,00	4.340,00
	3.640,00	3.740,00	4.840,00	4.940,00	4.840,00	4.940,00
	4.040,00	4.140,00	5.440,00	5.540,00	5.440,00	5.540,00
	4.440,00	4.540,00	6.040,00	6.140,00	6.040,00	6.140,00
	4.940,00	4.940,00	6.740,00	6.740,00	6.740,00	6.740,00
	5.340,00	5.340,00	7.340,00	7.340,00	7.340,00	7.340,00
	5.740,00	5.740,00	7.940,00	7.940,00	7.940,00	7.940,00
	6.120,00	6.140,00	7.520,00	8.540,00	7.520,00	8.540,00
	6.600,00	6.540,00	9.200,00	9.140,00	9.200,00	9.140,00
	7.000,00	6.940,00	9.800,00	9.740,00	9.800,00	9.740,00
	7.400,00	7.340,00	10.400,00	10.340,00	10.400,00	10.340,00
	7.800,00	7.740,00	11.000,00	10.940,00	11.000,00	10.940,00
	8.340,00	8.140,00	11.740,00	11.540,00	11.740,00	11.540,00
	8.740,00	8.540,00	12.340,00	12.140,00	12.340,00	12.140,00
	9.140,00	8.940,00	12.940,00	12.740,00	12.940,00	12.740,00
	9.540,00	9.340,00	13.540,00	13.340,00	13.540,00	13.340,00
	10.120,00	9.740,00	14.140,00	13.940,00	14.140,00	13.940,00
	10.520,00	10.140,00	14.740,00	14.540,00	14.740,00	14.540,00
	10.920,00	10.340,00	15.340,00	14.140,00	15.340,00	14.140,00
	11.320,00	10.940,00	15.940,00	15.740,00	15.940,00	15.740,00
	11.690,00	11.340,00	16.690,00	16.340,00	16.690,00	16.340,00
	180,00	180,00	180,00	180,00	180,00	180,00
	400,00	400,00	600,00	600,00	600,00	600,00
	200,00	200,00	200,00	200,00	200,00	200,00

GK-04-8 Güç Kaynağı Farkı

- Santral kapasitesi aşağıdaki tabloda verilmiştir.
- Kapasite aşıldığı durumda GK-04-8 ürünü ilave olarak verilmelidir.
- Güç kaynağı GK-04-8 santral kapasitesine eşdeğerdir.
- ND-110-8 güvenlik telefonuna en yakın santral 50 m'den uzak ise güvenlik noktasına bir adet GK-04-8 verilmelidir.

KABLO ÇEŞİDİ	MAX MOTİNÖR	MAX UZAKLIK
CAT6	(Ortalama 10 kat) 30 Monitör	30 m
CAT7	(Ortalama 15 kat) 45 Monitör	50 m

V-BUS7**INTERKOM SİSTEMLERİ****GÖRÜNTÜLÜ SİSTEM BUTONLU ZİL PANEL OLUŞTURMA KILAVUZU (8 KABLO)****TEK BUTONLU PANELLER İÇİN**

BUTON SAYISI	1. SIRA PANEL	2. SIRA PANEL	3. SIRA PANEL	ÖLÇÜ (MM)	TOPLAM FİYATI (TL)
1	8NDC-244-01	-	-	244	690,00
2	8NDC-244-02	-	-	244	690,00
3	8NDC-244-03	-	-	244	690,00
4	8NDC-244-04	-	-	244	690,00
5	8NDC-320-05	-	-	320	800,00
6	8NDC-320-06	-	-	320	800,00
7	8NDC-320-07	-	-	320	800,00
8	8NDC-320-08	-	-	320	800,00
9	8NDC-396-09	-	-	396	900,00
10	8NDC-396-10	-	-	396	900,00
11	8NDC-396-11	-	-	396	900,00
12	8NDC-396-12	-	-	396	900,00
13	8NDC-244-01	NDEK01-244-12	-	244	960,00
14	8NDC-244-02	NDEK01-244-12	-	244	960,00
15	8NDC-244-03	NDEK01-244-12	-	244	960,00
16	8NDC-244-04	NDEK01-244-12	-	244	960,00
17	8NDC-320-01	NDEK01-320-16	-	320	1.100,00
18	8NDC-320-02	NDEK01-320-16	-	320	1.100,00
19	8NDC-320-03	NDEK01-320-16	-	320	1.100,00
20	8NDC-320-04	NDEK01-320-16	-	320	1.100,00
21	8NDC-320-05	NDEK01-320-16	-	320	1.100,00
22	8NDC-320-06	NDEK01-320-16	-	320	1.100,00
23	8NDC-320-07	NDEK01-320-16	-	320	1.100,00
24	8NDC-320-08	NDEK01-320-16	-	320	1.100,00
25	8NDC-396-05	NDEK01-396-20	-	396	1.250,00
26	8NDC-396-06	NDEK01-396-20	-	396	1.250,00
27	8NDC-396-07	NDEK01-396-20	-	396	1.250,00
28	8NDC-396-08	NDEK01-396-20	-	396	1.250,00
29	8NDC-396-09	NDEK01-396-20	-	396	1.250,00
30	8NDC-396-10	NDEK01-396-20	-	396	1.250,00
31	8NDC-396-11	NDEK01-396-20	-	396	1.250,00
32	8NDC-396-12	NDEK01-396-20	-	396	1.250,00
33	8NDC-320-01	NDEK01-320-16	NDEK02-320-16	320	1.400,00
34	8NDC-320-02	NDEK01-320-16	NDEK02-320-16	320	1.400,00
35	8NDC-320-03	NDEK01-320-16	NDEK02-320-16	320	1.400,00
36	8NDC-320-04	NDEK01-320-16	NDEK02-320-16	320	1.400,00
37	8NDC-320-05	NDEK01-320-16	NDEK02-320-16	320	1.400,00
38	8NDC-320-06	NDEK01-320-16	NDEK02-320-16	320	1.400,00
39	8NDC-320-07	NDEK01-320-16	NDEK02-320-16	320	1.400,00
40	8NDC-320-08	NDEK01-320-16	NDEK02-320-16	320	1.400,00
41	8NDC-396-01	NDEK01-396-20	NDEK02-396-20	396	1.600,00
42	8NDC-396-02	NDEK01-396-20	NDEK02-396-20	396	1.600,00
43	8NDC-396-03	NDEK01-396-20	NDEK02-396-20	396	1.600,00
44	8NDC-396-04	NDEK01-396-20	NDEK02-396-20	396	1.600,00
45	8NDC-396-05	NDEK01-396-20	NDEK02-396-20	396	1.600,00
46	8NDC-396-06	NDEK01-396-20	NDEK02-396-20	396	1.600,00
47	8NDC-396-07	NDEK01-396-20	NDEK02-396-20	396	1.600,00
48	8NDC-396-08	NDEK01-396-20	NDEK02-396-20	396	1.600,00
49	8NDC-396-09	NDEK01-396-20	NDEK02-396-20	396	1.600,00
50	8NDC-396-10	NDEK01-396-20	NDEK02-396-20	396	1.600,00
51	8NDC-396-11	NDEK01-396-20	NDEK02-396-20	396	1.600,00
52	8NDC-396-12	NDEK01-396-20	NDEK02-396-20	396	1.600,00

MULTİ APARTMAN DİAFON SİSTEMLERİ

INTERKOM SİSTEMLERİ

INTERKOM SİSTEMLERİ

YANGIN ALGILAMA ve ACIL AYDINLATMA &
YÖNLENDİRME SİSTEMLERİ

LED AYDINLATMA SİSTEMLERİ

SENSÖR ve SENSÖRLÜ
AYDINLATMA SİSTEMLERİ

MULTİ APARTMAN DİAFON SİSTEMLERİ

INTERKOM SİSTEMLERİ

50010

KAPI GÖRÜŞMELİ DİAFON SİSTEMİ

- Zil Paneli ile Gizlilikli Görüşme
- Kapı Otomatığı Kontrolü
- Kapı Otomatığı Kontrolü



44,00 TL

Çalışma Gerilimi Santralden	Kapı Otomatığı Key	Gizli Görüşme Phone
Çalışma Sıcaklığı -20°C ~ +40°C	Koruma Derecesi IP 20 II Sınıfı	2 YEARS GUARANTEE CE

50012

KAPI VE KAPICI GÖRÜŞMELİ DİAFON SİSTEMİ

- Zil Paneli ile Gizlilikli Görüşme
- Kapıcı ile Gizlilikli Görüşme
- Kapı Otomatığı Kontrolü



46,00 TL

Çalışma Gerilimi Santralden	Kapı Otomatığı Key	Gizli Görüşme Phone
Çalışma Sıcaklığı -20°C ~ +40°C	Koruma Derecesi IP 20 II Sınıfı	2 YEARS GUARANTEE CE

50014

KAPICI GÖRÜŞMELİ DİAFON SİSTEMİ

- Zil Paneli ile Gizlilikli Görüşme
- Kapı Otomatığı Kontrolü



55,00 TL

Çalışma Gerilimi Santralden	Kapı Otomatığı Key	Gizli Görüşme Phone
Çalışma Sıcaklığı -20°C ~ +40°C	Koruma Derecesi IP 20 II Sınıfı	2 YEARS GUARANTEE CE

MULTİ APARTMAN DİAFON SİSTEMLERİ

INTERKOM SİSTEMLERİ



50040

APARTMAN TİPİ DİAFON SANTRALİ



- Kapı Otomatiği Kontrolü
- İki Farklı Zil Sesi Seçeneği
- Kapıcı ile Görüşme
- Kısa Devre Korumalı Dahili Güç Kaynağı
- Ray tipi montaj

240,00 TL

Çalışma Gerilimi	Ayarlar	Gizli Görüşme
 230-240V-50/60Hz		

Ürün Ölçüleri	Çalışma Sıcaklığı	Koruma Derecesi
DIN 13	 -20°C - +40°C	IP 20 II Sınıf



50041

APARTMAN TİPİ DİAFON SANTRALİ



- Kapı Otomatiği Kontrolü
- Çift Kapı Seçmeli
- Merdiven Otomatiği Kontrolü
- İki Farklı Zil Sesi Seçeneği
- Kapıcı ile Görüşme
- Kısa Devre Korumalı Dahili Güç Kaynağı

400,00 TL

Çalışma Gerilimi	Ayarlar	Gizli Görüşme
 230-240V-50/60Hz		

Ürün Ölçüleri	Çalışma Sıcaklığı	Koruma Derecesi
DIN 13	 -20°C - +40°C	IP 20 II Sınıf



MULTİ APARTMAN DİAFON SİSTEMLERİ

INTERKOM SİSTEMLERİ

50022

APARTMAN TİPİ KAPICISIZ ÇİFT ZİLLİ DİAFON SANTRALI

- Kapı Otomatığı Kontrolü
- İki Farklı Zil Sesi Seçeneği
- Kısa Devre Korumalı Dahili Güç Kaynağı
- Ray montaj



240,00 TL

Çalışma Gerilimi 230-240V-50/60Hz	Ayarlar	Gizli Görüşme
Çalışma Sıcaklığı -20°C ~ +40°C	Koruma Derecesi IP 20 II Sınıfı	2 YEARS GUARANTY

CE

50032

APARTMAN TİPİ KAPICILI ÇİFT ZİLLİ DİAFON SANTRALI

- Kapı Otomatığı Kontrolü
- İki Farklı Zil Sesi Seçeneği
- Kapıcı ile Görüşme
- Kısa Devre Korumalı Dahili Güç Kaynağı



300,00 TL

Çalışma Gerilimi 230-240V-50/60Hz	Ayarlar	Gizli Görüşme
Ürün Ölçüleri DIN 13	Çalışma Sıcaklığı -20°C ~ +40°C	Koruma Derecesi IP 20 II Sınıfı

2 YEARS GUARANTY

CE

MULTİ APARTMAN DİAFON SİSTEMLERİ

INTERKOM SİSTEMLERİ

APARTMAN TİPİ TEK BUTONLU DİAFON ZİL PANELLERİ

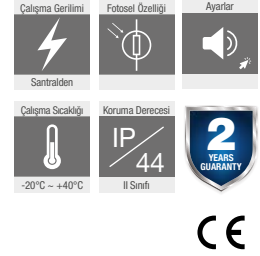

HOPARLÖRLÜ

ÜRÜN KOD	BUTON SAYISI	FİYAT (TL)
HP01-208 mm	1	140,00
HP02-234 mm	2	155,00
HP03-261 mm	3	170,00
HP04-287 mm	4	185,00
HP05-313 mm	5	200,00
HP06-339 mm	6	215,00
HP07-365 mm	7	230,00
HP08-391 mm	8	245,00
HP09-418 mm	9	260,00
HP010-444 mm	10	275,00
HP011-470 mm	11	290,00
HP012-496 mm	12	305,00

HOPARLÖRSÜZ

ÜRÜN KOD	BUTON SAYISI	FİYAT (TL)
HS04-208 mm	4	167,00
HS05-234 mm	5	182,00
HS06-261 mm	6	207,00
HS07-287 mm	7	222,00
HS08-313 mm	8	237,00
HS09-339 mm	9	252,00
HS010-365 mm	10	267,00
HS011-391 mm	11	282,00
HS012-418 mm	12	297,00
HS013-444 mm	13	312,00
HS014-470 mm	14	327,00
HS015-496 mm	15	342,00

HOPARLÖRSÜZ

ÜRÜN KOD	BUTON SAYISI	FİYAT (TL)
HS05-208 mm	5	182,00
HS06-234 mm	6	207,00
HS07-261 mm	7	222,00
HS08-287 mm	8	237,00
HS09-313 mm	9	252,00
HS010-339 mm	10	267,00
HS011-365 mm	11	282,00
HS012-391 mm	12	297,00
HS013-418 mm	13	312,00
HS014-444 mm	14	327,00
HS015-470 mm	15	342,00
HS016-496 mm	16	357,00

MULTİ APARTMAN DİAFON SİSTEMLERİ

INTERKOM SİSTEMLERİ

APARTMAN TİPİ ÇİFT BUTONLU DİAFON ZİL PANELLERİ



CE

HOPARLÖRLÜ

ÜRÜN KOD	BUTON SAYISI	FİYAT (TL)
HPÇ02-208 mm	2	160,00
HPÇ04-234 mm	4	177,00
HPÇ06-261 mm	6	194,00
HPÇ08-287 mm	8	211,00
HPÇ10-313 mm	10	228,00
HPÇ12-339 mm	12	245,00
HPÇ14-365 mm	14	262,00
HPÇ16-391 mm	16	279,00
HPÇ18-418 mm	18	296,00
HPÇ20-444 mm	20	313,00
HPÇ22-470 mm	22	330,00
HPÇ24-496 mm	22	347,00

HOPARLÖRSÜZ

ÜRÜN KOD	BUTON SAYISI	FİYAT (TL)
HŞÇ08-208 mm	8	193,00
HŞÇ10-234 mm	10	210,00
HŞÇ12-261 mm	12	227,00
HŞÇ14-287 mm	14	244,00
HŞÇ16-313 mm	16	261,00
HŞÇ18-339 mm	18	278,00
HŞÇ20-365 mm	20	295,00
HŞÇ22-391 mm	22	312,00
HŞÇ24-418 mm	24	329,00
HŞÇ26-444 mm	26	346,00
HŞÇ28-470 mm	28	363,00
HŞÇ30-496 mm	30	380,00

HOPARLÖRSÜZ

ÜRÜN KOD	BUTON SAYISI	FİYAT (TL)
HŞÇ10-208 mm	10	210,00
HŞÇ12-234 mm	12	227,00
HŞÇ14-261 mm	14	244,00
HŞÇ16-287 mm	16	261,00
HŞÇ18-313 mm	18	278,00
HŞÇ20-339 mm	20	295,00
HŞÇ22-365 mm	22	312,00
HŞÇ24-391 mm	24	329,00
HŞÇ26-418 mm	26	346,00
HŞÇ28-444 mm	28	363,00
HŞÇ30-470 mm	30	380,00
HŞÇ32-496 mm	32	397,00

MULTİ APARTMAN DİAFON SİSTEMLERİ

INTERKOM SİSTEMLERİ

APARTMAN TİPİ DİAFON SİSTEM FİYAT TABLOSU (8+n)



DAİRE SAYISI	KAPI KAPI OTOMATIĞI FİYAT (TL)	KAPI + KAPICI KAPI OTOMATIĞI FİYAT (TL)
1	424,00	556,00
2	483,00	617,00
3	542,00	678,00
4	601,00	739,00
5	660,00	800,00
6	719,00	861,00
7	778,00	922,00
8	837,00	983,00
9	896,00	1.044,00
10	955,00	1.105,00
11	1.014,00	1.166,00
12	1.073,00	1.344,00
13	1.249,00	1.405,00
14	1.308,00	1.466,00
15	1.367,00	1.527,00
16	1.426,00	1.588,00
17	1.485,00	1.649,00
18	1.544,00	1.710,00
19	1.603,00	1.771,00
20	1.662,00	1.832,00
21	1.721,00	1.793,00
22	1.780,00	1.954,00
23	1.839,00	2.015,00
24	1.898,00	2.076,00

- Kapı ile konuşan sistem fiyatlarında 50022 santral kullanılmıştır.
- Kapı + kapıcı ile konuşan sistem fiyatlarında 50040 santral kullanılmıştır.
- Sistem fiyatlarında tek sıra butonlu zil paneli kullanılmıştır.



MULTİ APARTMAN DİAFON SİSTEMLERİ

INTERKOM SİSTEMLERİ

APARTMAN TİPİ DİAFON SİSTEM BLOK ŞEMASI

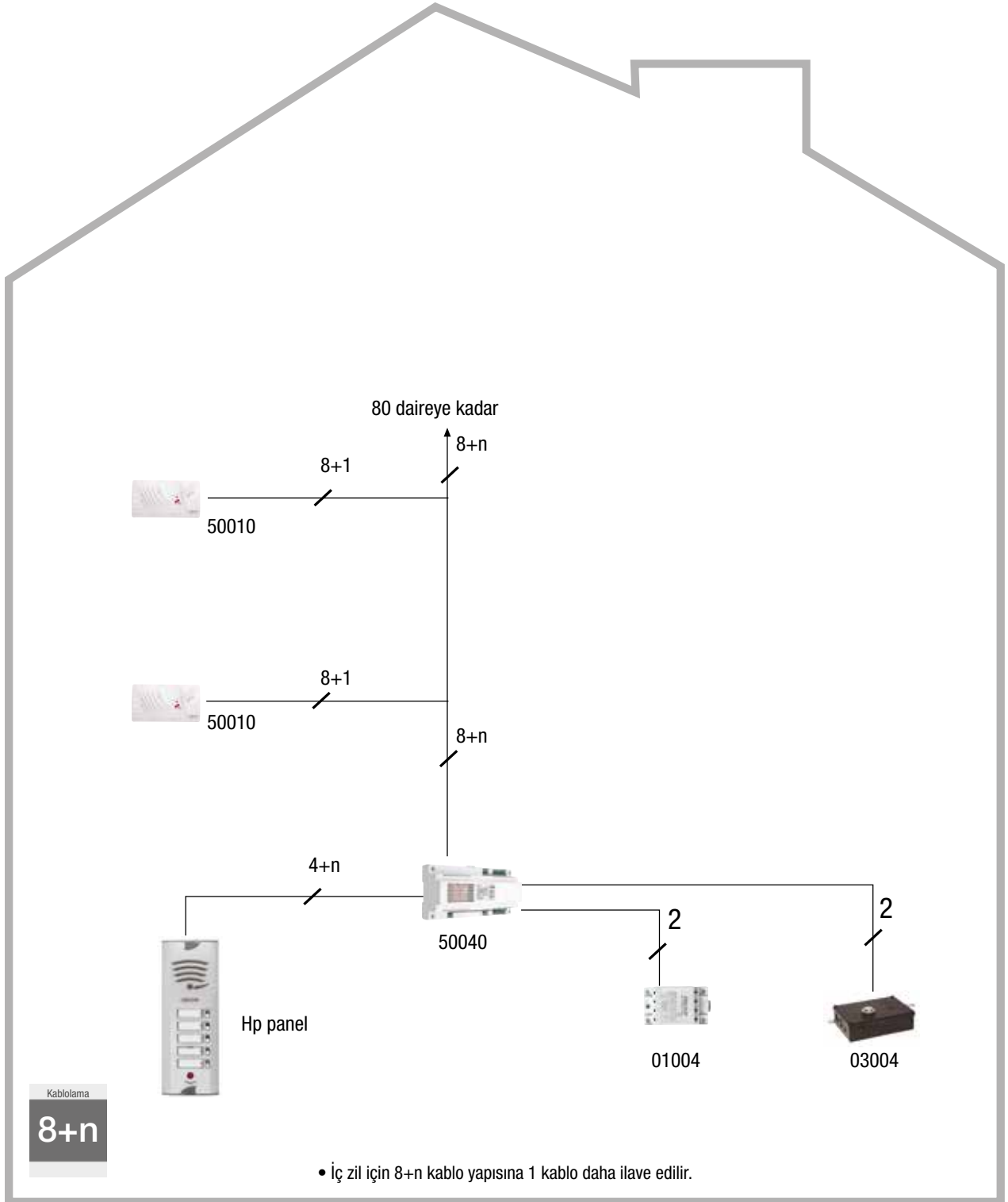

MULTİ APARTMAN DİAFON SİSTEMLERİ

INTERKOM SİSTEMLERİ

DİAFON SİSTEMLERİ İÇİN ZİL PANELİ EK SIRA OLUŞTURMA KLAVUZU

TEK BUTONLU PANELLER İÇİN

DAİRE SAYISI	1. PANEL	2. PANEL	3. PANEL
1	HP01-208mm		
2	HP02-234mm		
3	HP03-261mm		
4	HP04-287mm		
5	HP05-313mm		
6	HP06-339mm		
7	HP07-365mm		
8	HP08-391mm		
9	HP09-418mm		
10	HP10-444mm		
11	HP11-470mm		
12	HP12-496mm		
13	HP05-313mm	HS08-313mm	
14	HP05-313mm	HS09-313mm	
15	HP06-339mm	HS09-339mm	
16	HP06-339mm	HS10-339mm	
17	HP07-365mm	HS10-365mm	
18	HP07-365mm	HS11-365mm	
19	HP08-391mm	HS11-391mm	
20	HP08-391mm	HS12-391mm	
21	HP09-418mm	HS12-418mm	
22	HP09-418mm	HS13-418mm	
23	HP10-444mm	HS13-444mm	
24	HP10-444mm	HS14-444mm	
25	HP11-470mm	HS14-470mm	
26	HP11-470mm	HS15-470mm	
27	HP12-496mm	HS15-496mm	
28	HP12-496mm	HS16-496mm	
29	HP07-365mm	HS11-365mm	HS11-365mm
30	HP08-391mm	HS11-391mm	HS11-391mm
31	HP08-391mm	HS11-391mm	HS12-391mm
32	HP08-391mm	HS12-391mm	HS12-391mm
33	HP09-418mm	HS12-418mm	HS12-418mm
34	HP09-418mm	HS12-418mm	HS13-418mm
35	HP09-418mm	HS13-418mm	HS13-418mm
36	HP10-444mm	HS13-444mm	HS13-444mm
37	HP10-444mm	HS13-444mm	HS14-444mm
38	HP10-444mm	HS14-444mm	HS14-444mm
39	HP11-470mm	HS14-470mm	HS14-470mm
40	HP11-470mm	HS14-470mm	HS15-470mm
41	HP11-470mm	HS15-470mm	HS15-470mm
42	HP12-496mm	HS15-496mm	HS15-496mm
43	HP12-496mm	HS15-496mm	HS16-496mm
44	HP12-496mm	HS16-496mm	HS16-496mm

ÇİFT BUTONLU PANELLER İÇİN

DAİRE SAYISI	1. PANEL	2. PANEL	3. PANEL
2	HPÇ02-208mm		
4	HPÇ04-234mm		
6	HPÇ06-261mm		
8	HPÇ08-287mm		
10	HPÇ10-313mm		
12	HPÇ12-339mm		
14	HPÇ14-365mm		
16	HPÇ16-391mm		
18	HPÇ18-418mm		
20	HPÇ20-444mm		
22	HPÇ22-470mm		
24	HPÇ24-496mm		
26	HPÇ10-313mm	HSÇ16-313mm	
28	HPÇ10-313mm	HSÇ18-313mm	
30	HPÇ12-339mm	HSÇ18-339mm	
32	HPÇ12-339mm	HSÇ20-339mm	
34	HPÇ14-365mm	HSÇ20-365mm	
36	HPÇ14-365mm	HSÇ22-365mm	
38	HPÇ16-391mm	HSÇ22-391mm	
40	HPÇ16-391mm	HSÇ24-391mm	
42	HPÇ18-418mm	HSÇ24-418mm	
44	HPÇ18-418mm	HSÇ26-418mm	
46	HPÇ20-444mm	HSÇ26-444mm	
48	HPÇ20-444mm	HSÇ28-444mm	
50	HPÇ22-470mm	HSÇ28-470mm	
52	HPÇ22-470mm	HSÇ30-470mm	
54	HPÇ24-496mm	HSÇ30-496mm	
56	HPÇ24-496mm	HSÇ32-496mm	
58	HPÇ14-365mm	HSÇ22-365mm	HSÇ22-365mm
60	HPÇ16-391mm	HSÇ22-391mm	HSÇ22-391mm
62	HPÇ16-391mm	HSÇ22-391mm	HSÇ24-391mm
64	HPÇ16-391mm	HSÇ24-391mm	HSÇ24-391mm
66	HPÇ18-418mm	HSÇ24-418mm	HSÇ24-418mm
68	HPÇ18-418mm	HSÇ24-418mm	HSÇ26-418mm
70	HPÇ18-418mm	HSÇ26-418mm	HSÇ26-418mm
72	HPÇ20-444mm	HSÇ26-444mm	HSÇ26-444mm
74	HPÇ20-444mm	HSÇ26-444mm	HSÇ28-444mm
76	HPÇ20-444mm	HSÇ28-444mm	HSÇ28-444mm
78	HPÇ22-470mm	HSÇ28-470mm	HSÇ28-470mm
80	HPÇ22-470mm	HSÇ28-470mm	HSÇ30-470mm
82	HPÇ22-470mm	HSÇ30-470mm	HSÇ30-470mm
84	HPÇ24-496mm	HSÇ30-496mm	HSÇ30-496mm
86	HPÇ24-496mm	HSÇ30-496mm	HSÇ32-496mm
88	HPÇ24-496mm	HSÇ32-496mm	HSÇ32-496mm

VILLA SET

INTERKOM SİSTEMLERİ

VİLLA SET

INTERKOM SİSTEMLERİ

7" EKRANLI GÖRÜNTÜLÜ VİLLA SET



Çalışma Gerilimi 100-240V-50-60Hz	Çıkış Gerilimi +15V DC	Akım 1,5A DC
Panel Görüntüleme	CCTV	İlave Monitör Arama
Monitör 7" Renkli	Kapı Otomatığı	Ayarlar
Çalışma Sıcaklığı 0°C ~ +40°C	Koruma Derecesi IP 20 II Sınıfı	2 YEARS GUARANTY

CE

07041EBM (MONİTÖR)

- 7" Yüksek Çözünürlüklü LCD Ekran
- Eller Serbest (Handsfree) Konuşma Özelliği
- Kullanıcı Dostu Arayüz
- Monitörler Arasında Görüşme Yapabilme
- Kapı Otomatığı Kontrolü
- Dış Kapı ve İstenilen CCTV Kamerayı Görüntüleyebilme Özelliği
- Ayarlanabilen Parlaklık, Zıtlık, Renk ve Ses
- Rahatsız Etmeyin Özelliği
- İlave Monitör Bağlama Seçeneği
- İlave Panel Bağlama Seçeneği

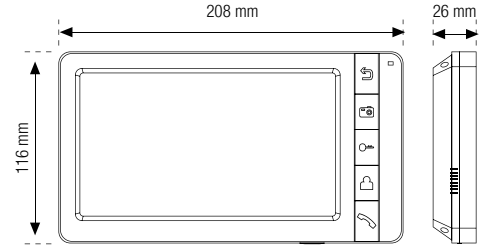

05104EBM (PANEL)

- 1/4" CMOS Renkli Kamera (800TVL)
- LED Işıklı Gece Görüşü
- 110° Görüş açısı
- Su Geçirmez
- Sıva üstü Montaj
- Paslanmaz çelik Metal Aksam
- Ön Panel Paslanmaz Çelik
- Kilit Kontrolünü Destekleyici Sistem

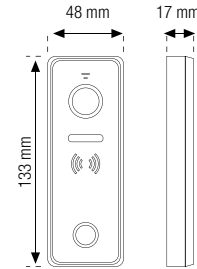

ÜRÜN KOD	ÜRÜN ÖZELLİKLERİ	FİYAT (TL)
17041EBM	7" görüntülü handsfree 1'li villa set (4 kablo)	1.340,00
27041EBM	7" görüntülü handsfree 2'li villa set (4 kablo)	2.220,00
37041EBM	7" görüntülü handsfree 3'lü villa set (4 kablo)	3.100,00
47041EBM	7" görüntülü handsfree 4'lü villa set (4 kablo)	3.980,00
07041EBM	7" görüntülü handsfree renkli monitör	880,00
05104EBM	Renkli kameralı zil paneli	460,00

VİLLA SET

INTERKOM SİSTEMLERİ

4 DAİRE'YE KADAR

EKONOMİK SETLER



- 4 Daireye Kadar Paket Olarak Satılır
- Tek Buton ile 4 Dairenin Zili Aynı Anda Çalar
- 4+n Kablo Alt Yapısı

TELEFONLU VİLLA SETLER (4+n)

ÜRÜN KOD	ÜRÜN ÖZELLİKLERİ	FİYAT (TL)
90028	Villa set 1 (1 daire için)	350,00
90029	Villa set 2 (2 daire için)	420,00
90030	Villa set 3 (3 daire için)	490,00
90031	Villa set 4 (4 daire için)	560,00

20 DAİRE'YE KADAR

EKONOMİK SETLER



- 20 Daireye Kadar Paket Olarak Satılır
- Tek Zil'li
- 4+n Kablo Alt Yapısı

TELEFONLU EKONOMİK SETLER (4+n)

ÜRÜN KOD	ÜRÜN ÖZELLİKLERİ	FİYAT (TL)
TES 01	Telefonlu ekonomik set (1 daire için)	350,00
TES 02	Telefonlu ekonomik set (2 daire için)	420,00
TES 03	Telefonlu ekonomik set (3 daire için)	490,00
TES 04	Telefonlu ekonomik set (4 daire için)	560,00
TES 05	Telefonlu ekonomik set (5 daire için)	630,00
TES 06	Telefonlu ekonomik set (6 daire için)	700,00
TES 07	Telefonlu ekonomik set (7 daire için)	770,00
TES 08	Telefonlu ekonomik set (8 daire için)	840,00
TES 09	Telefonlu ekonomik set (9 daire için)	910,00
TES 10	Telefonlu ekonomik set (10 daire için)	980,00

ÜRÜN KOD	ÜRÜN ÖZELLİKLERİ	FİYAT (TL)
TES 11	Telefonlu ekonomik set (11 daire için)	1.050,00
TES 12	Telefonlu ekonomik set (12 daire için)	1.120,00
TES 13	Telefonlu ekonomik set (13 daire için)	1.190,00
TES 14	Telefonlu ekonomik set (14 daire için)	1.260,00
TES 15	Telefonlu ekonomik set (15 daire için)	1.330,00
TES 16	Telefonlu ekonomik set (16 daire için)	1.400,00
TES 17	Telefonlu ekonomik set (17 daire için)	1.470,00
TES 18	Telefonlu ekonomik set (18 daire için)	1.540,00
TES 19	Telefonlu ekonomik set (19 daire için)	1.610,00
TES 20	Telefonlu ekonomik set (20 daire için)	1.680,00

**KAPI VE MERDİVEN OTOMATİKLERİ,
ZİL TRANSFORMATÖRLERİ, ZİL BUTONLARI**

INTERKOM SİSTEMLERİ

INTERKOM SİSTEMLERİ

YANGIN ALGILAMA ve ACIL AYDINLATMA &
YÖNLENDİRME SİSTEMLERİ

LED AYDINLATMA SİSTEMLERİ

SENSÖR ve SENSÖRLÜ
AYDINLATMA SİSTEMLERİ

MERDİVEN VE KAPI OTOMATİKLERİ, ZİL TRANSFORMATÖRLERİ

INTERKOM SİSTEMLERİ

W OTOMAT TİPİ MERDİVEN OTOMATIĞI 16A

03006

- Devamlı - Otomatik seçeneği
- 2 sn - 5 dk arası zaman seçeneği
- Din 1 ray tipi panoya kolay montaj
- Sigorta korumalı
- 3200W'a kadar akkor ampul ve 1200W'a kadar floresan bağlanabilir.

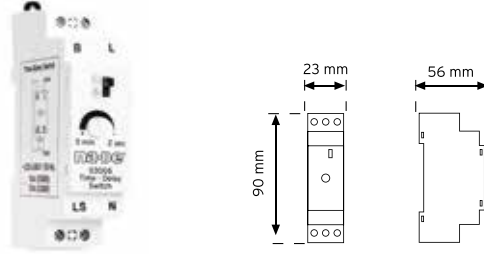

60,00 TL

Çalışma Gerilimi 230-240V - 50/60Hz	Aydınlatma Yüklü E27 Flo.	Zaman Ayarı 2 sn - 5 dk
Çalışma Sıcaklığı -20°C ~ +40°C	Koruma Derecesi IP 20 II Sınıfı	Koli Bilgisi 2 kg 24 Adet 30,50x16,00x10,50
2 YEARS GUARANTY		
CE		

W OTOMAT TİPİ MERDİVEN OTOMATIĞI 10A

03009

- Devamlı - Otomatik seçeneği
- 2 sn - 5 dk arası zaman seçeneği
- Din 1 ray tipi panoya kolay montaj
- Sigorta korumalı
- 2000W'a kadar akkor ampul ve 800W'a kadar floresan bağlanabilir.

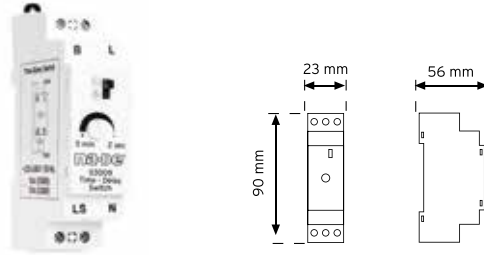

60,00 TL

Çalışma Gerilimi 230-240V - 50/60Hz	Aydınlatma Yüklü E27 Flo.	Zaman Ayarı 2 sn - 5 dk
Çalışma Sıcaklığı -20°C ~ +40°C	Koruma Derecesi IP 20 II Sınıfı	Koli Bilgisi 2 kg 24 Adet 30,50x16,00x10,50
2 YEARS GUARANTY		
CE		

DÖKÜM KAPI OTOMATIĞI (MEKANİK BUTONLU)

03004

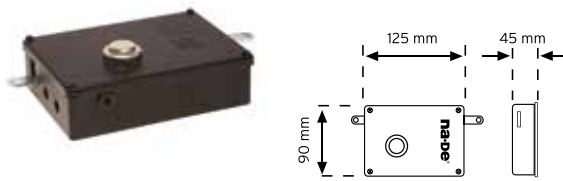

80,00 TL

Çalışma Gerilimi 12V AC / 12V DC	Sürme Akımı Max 1A	Çalışma Sıcaklığı -20°C ~ +40°C
Koruma Derecesi IP 20 II Sınıfı	Koli Bilgisi 17 kg 24 Adet 42,00x29,50x21,00	2 YEARS GUARANTY
CE		

12V / 4VA AC ZİL TRANSFORMATÖRÜ

01004

- Kısa devre korumalı

 Ürün Ölçüleri
Din 3

40,00 TL

Çalışma Gerilimi 230-240V - 50/60Hz	Çıkış V/A 12Vac / 4V A	Kısa Devre Koruması PTC
Çalışma Sıcaklığı -20°C ~ +40°C	Koruma Derecesi IP 20 II Sınıfı	Koli Bilgisi 15,5 kg 60 Adet 30,00x26,50x16,60
2 YEARS GUARANTY		
CE		

MERDİVEN VE KAPI OTOMATİKLERİ, ZİL TRANSFORMATÖRLERİ INTERKOM SİSTEMLERİ

15V / 15VA ZİL TRANSFORMATÖRÜ

01002

- Kısa devre korumalı



Ürün Ölçüleri
Din 4

Çalışma Genilimi	Çıkış	Kısa Devre Koruması
230-240V - 50/60Hz	15Vac / 15V A	PTC
Çalışma Sıcaklığı	Koruma Derecesi	Koli Bilgisi
-20°C ~ +40°C	IP 20 II Sınıfı	21 kg 30 Adet 30.00x26.50x16.60
TS EN 61558-2-8		
2 YEARS GUARANTY		
CE		

24V / 15VA ZİL TRANSFORMATÖRÜ

01003

- Kısa devre korumalı



Ürün Ölçüleri
Din 4

Çalışma Genilimi	Çıkış	Kısa Devre Koruması
230-240V - 50/60Hz	24Vac / 15V A	PTC
Çalışma Sıcaklığı	Koruma Derecesi	Koli Bilgisi
-20°C ~ +40°C	IP 20 II Sınıfı	18 kg 20 Adet 40.50x29.00x18.00
TS EN 61558-2-8		
2 YEARS GUARANTY		
CE		

15V / 30VA AC ZİL TRANSFORMATÖRÜ

01005

- Kısa devre korumalı



Ürün Ölçüleri
Din 4

Çalışma Genilimi	Çıkış	Kısa Devre Koruması
230-240V - 50/60Hz	15Vac / 30V A	PTC
Çalışma Sıcaklığı	Koruma Derecesi	Koli Bilgisi
-20°C ~ +40°C	IP 20 II Sınıfı	17.5 kg 20 Adet 40.50x29.00x18.00
TS EN 61558-2-8		
2 YEARS GUARANTY		
CE		

24V / 50VA AC ZİL TRANSFORMATÖRÜ

01006

- Kısa devre korumalı



Ürün Ölçüleri
Din 4

Çalışma Genilimi	Çıkış	Kısa Devre Koruması
230-240V - 50/60Hz	24Vac / 50V A	PTC
Çalışma Sıcaklığı	Koruma Derecesi	Koli Bilgisi
-20°C ~ +40°C	IP 20 II Sınıfı	16 kg 24 Adet 42.00x27.00x22.00
TS EN 61558-2-8		
2 YEARS GUARANTY		
CE		

INTERKOM SİSTEMLERİ

YANGIN ALGILAMA ve ACIL AYDINLATMA &
YÖNLENDİRME SİSTEMLERİ









LED AYDINLATMA SİSTEMLERİ

SENSÖR ve SENSÖRLÜ
AYDINLATMA SİSTEMLERİ

ZİL BUTONLARI

INTERKOM SİSTEMLERİ

ALÜMİNYUM ZİL BUTONLARI

07001 10,00 TL	07002 14,00 TL	07003 20,00 TL	07004 26,00 TL	07005 32,00 TL
				
				
07010 62,00 TL	07009 56,00 TL	07008 50,00 TL	07007 44,00 TL	07006 38,00 TL

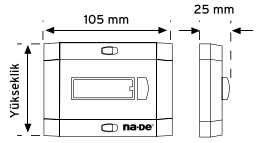

YÜKSEKLİK TABLOSU

07001	80 mm
07002	105 mm
07003	135 mm
07004	155 mm
07005	185 mm
07006	210 mm
07007	240 mm
07008	265 mm
07009	295 mm
07010	320 mm

LED'Lİ IŞIKLI ZİL BUTONLARI

06001 33,00 TL	06002 41,80 TL	06003 50,60 TL	06004 59,40 TL	06005 68,20 TL
				
				
06010 112,20 TL	06009 103,40 TL	06008 94,60 TL	06007 85,80 TL	06006 77,00 TL

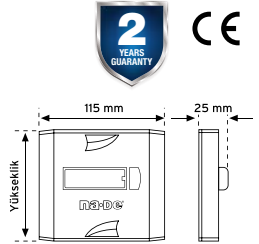

YÜKSEKLİK TABLOSU

06001	103 mm
06002	128 mm
06003	153 mm
06004	178 mm
06005	203 mm
06006	228 mm
06007	254 mm
06008	279 mm
06009	304 mm
06010	329 mm

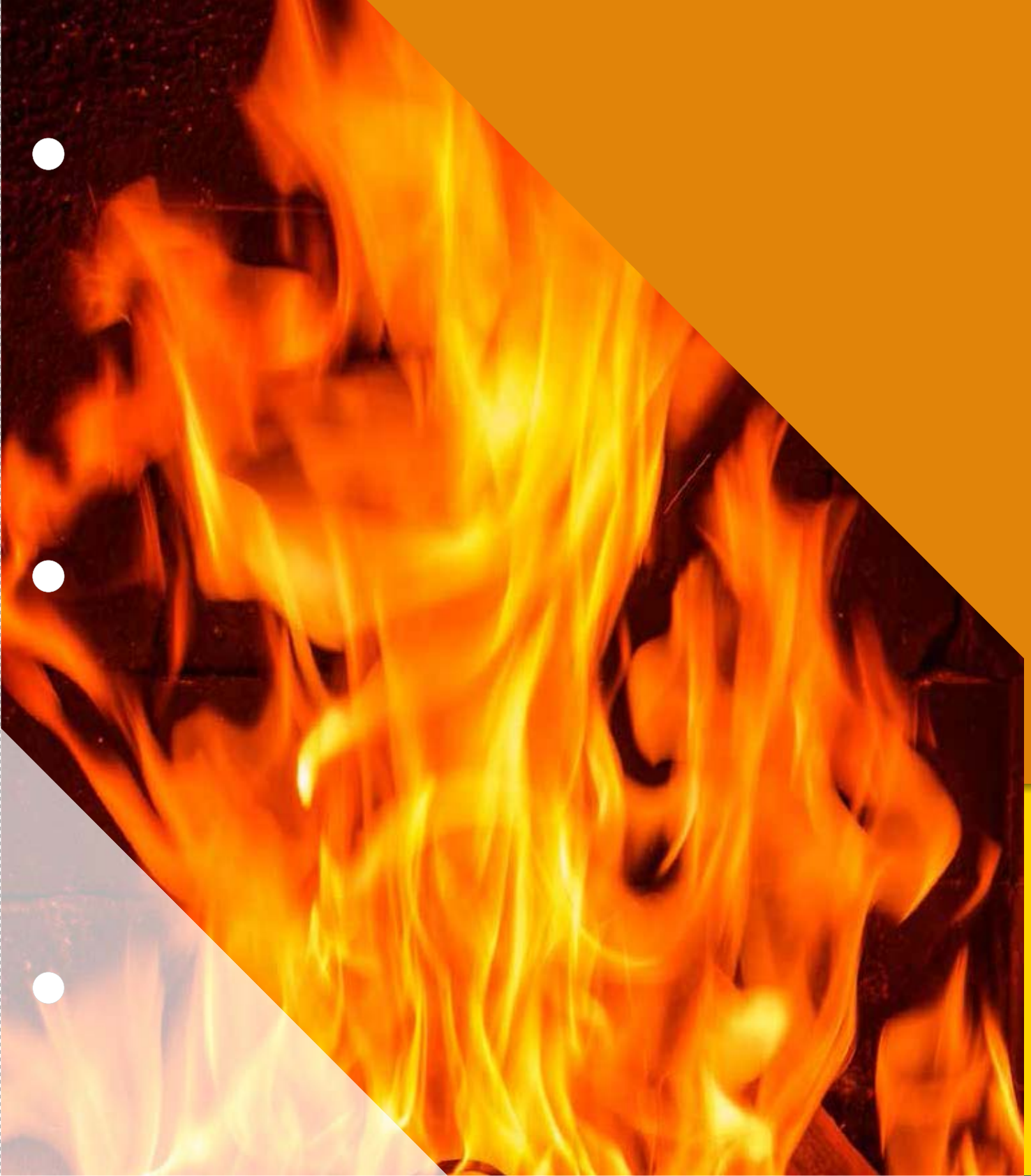

YANGIN ALGILAMA ve ACİL AYDINLATMA &
YÖNLENDİRME SİSTEMLERİ

LED AYDINLATMA SİSTEMLERİ

YANGIN ALGILAMA ve ACİL AYDINLATMA & YÖNLENDİRME SİSTEMLERİ

na·De®

SENSÖR ve SENSÖRLÜ
AYDINLATMA SİSTEMLERİ

YANGIN ALARM SİSTEMLERİ

YANGIN ALARM VE ACİL AYDINLATMA & YÖNLENDİRME SİSTEMLERİ

ADRESLENEBİLİR YANGIN ALARM SANTRALLERİ

IFS7002 YANGIN ALARM SANTRALI

\$ 850,00

- Dokunmatik Panelli Ekran
- Tek Sinyal Döngülü Sistem
- 125 Adres Destekler
- 64 Bölgeye Kadar Dahil Edilme Özelliği
- 2 Adet Ayarlanabilir Çıkış
- 1023 Adete Kadar Kalıcı Arşiv Hafızası
- 1 x CAN Arayüzü
- 1 x RS232 Arayüzü



ADRESLENEBİLİR YANGIN ALARM SANTRALLERİ

IFS7002/2 YANGIN ALARM SANTRALI

\$ 1.500,00

- Dokunmatik Panelli Ekran
- İki Sinyal Döngülü Sistem
- 250 Adres Destekler
- 250 Bölgeye Kadar Dahil Edilme Özelliği
- 2 Adet Ayarlanabilir Çıkış
- 3 Adet Röle Çıkışı
- 1023 Adete Kadar Kalıcı Arşiv Hafızası
- 2 x CAN Arayüzü
- 1 x RS232 Arayüzü



ADRESLENEBİLİR YANGIN ALARM SANTRALLERİ

IFS7002/4 YANGIN ALARM SANTRALI

\$ 2.400,00

- Dokunmatik Panelli Ekran
- Dört Sinyal Döngülü Sistem
- 500 Adres Destekler
- 500 Bölgeye Kadar Dahil Edilme Özelliği
- 2 Adet Ayarlanabilir Çıkış
- 2046 Adete Kadar Kalıcı Arşiv Hafızası
- 2 x CAN Arayüzü
- 1 x RS232 Arayüzü



ADRESLENEBİLİR YANGIN ALARM SANTRALLERİ

IFS7002/R YANGIN ALARM SANTRALI

\$ 1.000,00

- Dokunmatik Panelli Ekran
- Dahili Buzzer
- Tekrarlayıcı Panel



YANGIN ALARM SİSTEMLERİ

YANGIN ALARM VE ACİL AYDINLATMA & YÖNLENDİRME SİSTEMLERİ

ADRESLENEBİLİR YANGIN DEDEKTÖRLERİ

FD7110 SABİT ISI DEDEKTÖRÜ

\$ 28,00

- Dahili İzolatör



ADRESLENEBİLİR YANGIN DEDEKTÖRLERİ

FD7120 ISI VE ISI ARTIŞ DEDEKTÖRÜ

\$ 28,00

- Kilit İçerikli Nokta Tipi
- Isı ve Isı Artış Yangın Dedektörü
- Dahili İzolatör



ADRESLENEBİLİR YANGIN DEDEKTÖRLERİ

FD7130 OPTİK DUMAN DEDEKTÖRÜ

\$ 28,00

- Dahili İzolatör



ADRESLENEBİLİR YANGIN DEDEKTÖRLERİ

FD7160 DUMAN VE ISI DEDEKTÖRÜ

\$ 37,00

- Optik Duman ve Isı Dedektörü
- Dahili İzolatör



YANGIN ALARM SİSTEMLERİ

YANGIN ALARM VE ACİL AYDINLATMA & YÖNLENDİRME SİSTEMLERİ

ADRESLENEBİLİR YANGIN ALARM BUTONU

FD7150 YANGIN ALARM BUTONU

\$ 43,00

- Resetlenebilir
- Şeffaf
- Kapaksız
- Dahili İzolatör



ADRESLENEBİLİR YANGIN ALARM AKSESUARLARI - 7000 SERİSİ

FD7201S ADAPTÖR

\$ 75,00

- Konvansiyonel Sistemi Adresleme Adaptörü
- Harici Beslemeli
- DB7100A ile Birlikte Kullanılır



ADRESLENEBİLİR YANGIN ALARM AKSESUARLARI - 7000 SERİSİ

FD7201SA

\$ 75,00

- Konvansiyonel Sistemi Adresleme Adaptörü
- Harici Beslemeli



ADRESLENEBİLİR YANGIN ALARM AKSESUARLARI - 7000 SERİSİ

FD7203

\$ 65,00

- Konvansiyonel Sistemi Adresleme Adaptörü
- Harici Beslemeli
- 1 Giriş
- 1 Çıkış



YANGIN ALARM SİSTEMLERİ

YANGIN ALARM VE ACİL AYDINLATMA & YÖNLENDİRME SİSTEMLERİ

ADRESLENEBİLİR YANGIN ALARM AKSESUARLARI - 7000 SERİSİ

FD7203 10/16

\$ 210,00

- 10 Giriş
- 16 Çıkış
- Harici Besleme



ADRESLENEBİLİR YANGIN ALARM AKSESUARLARI - 7000 SERİSİ

FD7203 3/6

\$ 120,00

- 3 Giriş
- 6 Çıkış
- Harici Besleme



ADRESLENEBİLİR YANGIN ALARM AKSESUARLARI - 7000 SERİSİ

FD7203R

\$ 85,00

- 1 Çıkış
- 2 İzolatör



ADRESLENEBİLİR YANGIN ALARM AKSESUARLARI - 7000 SERİSİ

FD7204 SİREN

\$ 80,00

- İzolatör İçerikli Siren
- DB7100 Serisi Alt Tabanı ile Birlikte Kullanılır



FD7204F SİREN

\$ 100,00

- İzolatör İçerikli Siren ve Uyarı Işığı
- DB7100 Serisi Alt Tabanı ile Birlikte Kullanılır



YANGIN ALARM SİSTEMLERİ

YANGIN ALARM VE ACİL AYDINLATMA & YÖNLENDİRME SİSTEMLERİ

ADRESLENEBİLİR YANGIN ALARM AKSESUARLARI - 7000 SERİSİ

TR6100-1 20-40 IŞIN
TİPİ DUMAN DEDEKTÖRÜ

\$ 850,00

- BEAM Duman Dedektörü
- 20-40 metre
- Reflektör Dahil

TR6100-2 40-70 IŞIN
TİPİ DUMAN DEDEKTÖRÜ

\$ 900,00

- BEAM Duman Dedektörü
- 40-70 metre
- Reflektör Dahil

ADRESLENEBİLİR YANGIN ALARM AKSESUARLARI - 7000 SERİSİ

TR6100-3 70-100 IŞIN
TİPİ DUMAN DEDEKTÖRÜ

\$ 950,00

- BEAM Duman Dedektörü
- 70-100 metre
- Reflektör Dahil

DB7100 TABAN

\$ 4,50

- Standart Dedektör Tabanı



ADRESLENEBİLİR YANGIN ALARM AKSESUARLARI - 7000 SERİSİ

CYS-4024
GÜÇ KAYNAĞI

\$ 44,00

- 24V / 1.5A Güç Kaynağı
- 10 Adet Siren Bağlanabilir

CYS-9024
GÜÇ KAYNAĞI

\$ 66,00

- 24V / 3A Güç Kaynağı
- 25 Adet Siren Bağlanabilir

ADRESLENEBİLİR YANGIN ALARM AKSESUARLARI - 7000 SERİSİ

CYS-12024
GÜÇ KAYNAĞI

\$ 88,00

- 24V – 5A, Güç Kaynağı
- 35 Adet Siren Bağlanabilir

CYS-18024
GÜÇ KAYNAĞI

\$ 110,00

- 24V / 7,5A Güç Kaynağı
- 50 Adet Siren Bağlanabilir

YANGIN ALARM SİSTEMLERİ

YANGIN ALARM VE ACİL AYDINLATMA & YÖNLENDİRME SİSTEMLERİ

ADRESLENEBİLİR YANGIN ALARM AKSESUARLARI - 7000 SERİSİ

NYS1.1 DOĞAL
GAZ DEDEKTÖRÜ

\$ 60,00

- 12/24V DC ile Çalışma

FXDCO
KARBONMOMOKSİT
DEDEKTÖRÜ

\$ 55,00

- Şarjlı Pili ve Elektrikli

ADRESLENEBİLİR YANGIN ALARM AKSESUARLARI - 7000 SERİSİ

FXDC01
KARBONMOMOKSİT
DEDEKTÖRÜ

\$ 55,00

- Pili ve Elektrikli

FXDC02
KARBONMOMOKSİT
DEDEKTÖRÜ

\$ 55,00

- Pili ile Çalışma

NDE01 DOĞALGAZ
DEDEKTÖRÜ

\$ 27,00

- Adreslenebilir
- 12-24V Besleme

TAMMY2
DEPREM SENSÖRÜ

\$ 250,00

- Deprem Sensörü
- Asansör Kullanımı İçin
- LED Göstergeli
- 4 Çıkışlı

TAMMY3
DEPREM SENSÖRÜ

\$ 360,00

- Deprem Sensörü
- Bina Kullanımı İçin
- LCD Göstergeli
- 4 Çıkışlı

NYS DOĞAL GAZ
DEDEKTÖRÜ

\$ 12,00

- 220V ile Çalışma

YANGIN ALARM SİSTEMLERİ

YANGIN ALARM VE ACİL AYDINLATMA & YÖNLENDİRME SİSTEMLERİ

KONVANSİYONEL YANGIN ALARM SİSTEMLERİ - 4000 SERİSİ

FS4000/2 YANGIN ALARM SANTRALİ

\$ 190,00

- Konvansiyonel Yangın Alarm Santrali
- 2 Adet Yangın Alarm Hattı
- 2 Adet SİREN Çıkışı
- 2 Adet Yangın için Röle Çıkışı
- 1 Adet Arıza için Röle Çıkışı



KONVANSİYONEL YANGIN ALARM SİSTEMLERİ - 4000 SERİSİ

FS4000/4 YANGIN ALARM SANTRALİ

\$ 210,00

- Konvansiyonel Yangın Alarm Santrali
- 4 Adet Yangın Alarm Hattı
- 2 Adet SİREN Çıkışı
- 2 Adet Yangın için Röle Çıkışı
- 1 Adet Arıza için Röle Çıkışı



KONVANSİYONEL YANGIN ALARM SİSTEMLERİ - 4000 SERİSİ

FS4000/6 YANGIN ALARM SANTRALİ

\$ 230,00

- Konvansiyonel Yangın Alarm Santrali
- 6 Adet Yangın Alarm Hattı
- 2 Adet SİREN Çıkışı
- 2 Adet Yangın için Röle Çıkışı
- 1 Adet Arıza için Röle Çıkışı



KONVANSİYONEL YANGIN ALARM SİSTEMLERİ - 4000 SERİSİ

FS4000/8 YANGIN ALARM SANTRALİ

\$ 260,00

- Konvansiyonel Yangın Alarm Santrali
- 8 Adet Yangın Alarm Hattı
- 2 Adet SİREN Çıkışı
- 2 Adet Yangın için Röle Çıkışı
- 1 Adet Arıza için Röle Çıkışı



YANGIN ALARM SİSTEMLERİ

YANGIN ALARM VE ACİL AYDINLATMA & YÖNLENDİRME SİSTEMLERİ

KONVANSİYONEL YANGIN ALARM SİSTEMLERİ - 4000 SERİSİ

FD4201/2 GENİŞLEME MODÜLÜ

\$ 85,00

- Konvansiyonel RÖLE Genişleme Modülü
- 2 Adet Yangın için Röle Çıkışı
- RS485 Arayüz



KONVANSİYONEL YANGIN ALARM SİSTEMLERİ - 4000 SERİSİ

FD4201/4 GENİŞLEME MODÜLÜ

\$ 108,00

- Konvansiyonel RÖLE Genişleme Modülü
- 4 Adet Yangın için Röle Çıkışı
- RS485 Arayüz



KONVANSİYONEL YANGIN ALARM SİSTEMLERİ - 4000 SERİSİ

FD4201/6 GENİŞLEME MODÜLÜ

\$ 120,00

- Konvansiyonel RÖLE Genişleme Modülü
- 6 Adet Yangın için Röle Çıkışı
- RS485 Arayüz



KONVANSİYONEL YANGIN ALARM SİSTEMLERİ - 4000 SERİSİ

FD4201/8 GENİŞLEME MODÜLÜ

\$ 126,00

- Konvansiyonel RÖLE Genişleme Modülü
- 8 Adet Yangın için Röle Çıkışı
- RS485 Arayüz



YANGIN ALARM SİSTEMLERİ

YANGIN ALARM VE ACİL AYDINLATMA & YÖNLENDİRME SİSTEMLERİ

KONVANSİYONEL YANGIN ALARM SİSTEMLERİ - 5100 SERİSİ

FS5100 YANGIN ALARM SANTRALİ

\$ 750,00

- 2 Adet Yangın Hattı
- 2 Adet SİREN Çıkışı
- 2 Adet Yangın için Röle Çıkışı
- 1 Adet Arıza için Röle Çıkışı
- Kalıcı Arşiv Hafızası
- LCD ekran
- 84 Olaya Kadar Dâhil Edilme Özelliği



KONVANSİYONEL YANGIN ALARM SİSTEMLERİ - 5100 SERİSİ

5101 GENİŞLEME MODÜLÜ

\$ 108,00

- FS5100 Santrali için Genişletme Modülü
- 3 Adet Yangın Hattı
- 3 Adet Yangın için Röle Çıkışı



KONVANSİYONEL YANGIN ALARM SİSTEMLERİ - 5100 SERİSİ

5102 GENİŞLEME MODÜLÜ

\$ 156,00

- FS5100 Santrali için Genişletme Modülü
- 6 Adet Yangın Hattı
- 3 Adet Yangın için Röle Çıkışı



YANGIN ALARM SİSTEMLERİ

YANGIN ALARM VE ACİL AYDINLATMA & YÖNLENDİRME SİSTEMLERİ

KONVANSİYONEL YANGIN ALARM SİSTEMLERİ - 5200 SERİSİ

FS200 YANGIN ALARM SANTRALİ

\$ 750,00

- Konvansiyonel Yangın Alarm Santrali
- 8 Adet Yangın Hattı
- 1 Adet SİREN Çıkışı
- 2 Adet Yangın için Röle Çıkışı
- 1 Adet Arıza için Röle Çıkışı
- Kalıcı Arşiv Hafızası
- LCD Ekran
- 256 Olaya Kadar Dahil Edilme Özelliği



KONVANSİYONEL YANGIN ALARM SİSTEMLERİ - 5200 SERİSİ

5201 GENİŞLEME MODÜLÜ

\$ 250,00

- FS5200 Santral ile Uyumlu
- 8 Adet Yangın Hattı

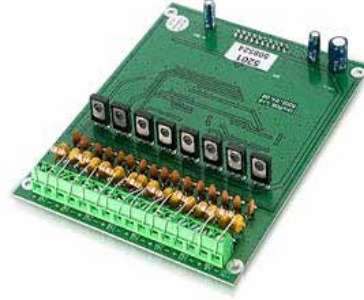

KONVANSİYONEL YANGIN ALARM SİSTEMLERİ - 5200 SERİSİ

5202 GENİŞLEME MODÜLÜ

\$ 312,00

- FS5200 Santrali ile Uyumlu
- 8 Adet Yangın Hattı
- 1 Adet SİREN Çıkışı



KONVANSİYONEL YANGIN ALARM SİSTEMLERİ - 5200 SERİSİ

5203 GENİŞLEME MODÜLÜ

\$ 252,00

- FS5200 Santral ile Uyumlu
- 8 Adet Yangın Hattı



YANGIN ALARM SİSTEMLERİ

YANGIN ALARM VE ACİL AYDINLATMA & YÖNLENDİRME SİSTEMLERİ

KONVANSİYONEL YANGIN ALARM SİSTEMLERİ - 5200 SERİSİ

5204 GENİŞLEME MODÜLÜ

\$ 350,00

- FS5200 Santral ile Uyumlu
- 16 Adet Yangın Hattı



KONVANSİYONEL YANGIN ALARM SİSTEMLERİ - 5200E SERİSİ

FS5200E YANGIN SÖNDÜRME SANTRALİ

\$ 900,00

- Yangın Söndürme Santrali,
- 3 Adet Yangın Alarm Hattı,
- 2 Adet Yangın Söndürme Amaçlı Alarm Hattı,
- 1 Adet Yangın Söndürme Kontrolü Olmayan Alarm Hattı,
- RS485 Arayüz



KONVANSİYONEL YANGIN ALARM SİSTEMLERİ - 5200E SERİSİ

FD5301 TEKRARLAYICI PANEL

\$ 250,00

- Yangın Söndürme Prosedür Kontrolü Sağlar
- Yangın Söndürme Prosedürünü Tekrarlar
- FS5200E Santrali ile Uyumludur



YANGIN ALARM SİSTEMLERİ

YANGIN ALARM VE ACİL AYDINLATMA & YÖNLENDİRME SİSTEMLERİ

KONVANSİYONEL YANGIN ALARM SİSTEMLERİ - 5200E SERİSİ

FD3050Y

\$ 23,00

- Serbest Bırakma Manuel Butonu
- Söndürmenin Manuel Etkinleştirilmesi için Kullanılır
- FS5200E Santrali ile Uyumludur



KONVANSİYONEL YANGIN ALARM SİSTEMLERİ - 5200E SERİSİ

FD3050G

\$ 23,00

- Ek Serbest Bırakma Butonu
- Otomatik Söndürmenin Etkinleştirilmesi için Kullanılır
- FS5200E Santrali ile Uyumludur



KONVANSİYONEL YANGIN ALARM SİSTEMLERİ - 5200E SERİSİ

FD3050B

\$ 23,00

- Acil Stop Butonu
- Söndürmeyi Tutmak Amacıyla Kullanılır
- Tahliye Süresinin Artırılmasını Sağlar
- FS5200E Santrali ile Uyumludur



KONVANSİYONEL YANGIN ALARM SİSTEMLERİ - 5200E SERİSİ

5302

\$ 29,00

- Rejim Seçim Anahtarı
- FS5200E Santralinin Çalışma Rejiminin Seçilmesi için Kullanılır



YANGIN ALARM SİSTEMLERİ

YANGIN ALARM VE ACİL AYDINLATMA & YÖNLENDİRME SİSTEMLERİ

KONVANSİYONEL YANGIN ALARM EKİPMANLARI

FD8010

\$ 16,00

- Sabit Isı Dedektörü



KONVANSİYONEL YANGIN ALARM EKİPMANLARI

FD8020

\$ 16,00

- Isı Artış Dedektörü



KONVANSİYONEL YANGIN ALARM EKİPMANLARI

FD8030

\$ 16,00

- Optik Duman Dedektörü



KONVANSİYONEL YANGIN ALARM EKİPMANLARI

FD8060

\$ 24,00

- Kombine Dedektör
- Optik Duman ve Isı Tespit Eder



YANGIN ALARM SİSTEMLERİ

YANGIN ALARM VE ACİL AYDINLATMA & YÖNLENDİRME SİSTEMLERİ

KONVANSİYONEL YANGIN ALARM EKİPMANLARI

FD8040

\$ 87,00

- Nokta Tipi Optik Alev Yangın Dedektörü
- Kilit Seçeneği Mevcuttur



KONVANSİYONEL YANGIN ALARM EKİPMANLARI

FD3050

\$ 14,00

- Yangın Alarm Butonu
- 10-30VDC
- Resetlenebilir
- Şeffaf ve Kapaksız



KONVANSİYONEL YANGIN ALARM EKİPMANLARI

DB8000

\$ 4,50

- Standart Dedektör Tabanı



KONVANSİYONEL YANGIN ALARM EKİPMANLARI

DB8000R

\$ 15,00

- Röle Altı Tabanı



YANGIN ALARM SİSTEMLERİ

YANGIN ALARM VE ACİL AYDINLATMA & YÖNLENDİRME SİSTEMLERİ

KONVANSİYONEL SİRENLER

SV 2002F

\$ 18,00

- Dahili Siren
- 112dB / 16-30V
- 16-30V



KONVANSİYONEL SİRENLER

SB 112F

\$ 94,00

- Harici Siren
- 110dB
- 12-30V



KONVANSİYONEL AKSESUARLAR

RI31

\$ 6,00

- Paralel İhbar Lambası



KONVANSİYONEL AKSESUARLAR

RI31S

\$ 14,00

- Mesafe Ses Göstergesi



YANGIN ALARM SİSTEMLERİ

YANGIN ALARM VE ACİL AYDINLATMA & YÖNLENDİRME SİSTEMLERİ

KONVANSİYONEL AKSESUARLAR

YKB02K

\$ 240,00

- Boru TİPİ Duman Dedektörü
- Konvansiyonel Duman Dedektörü
- Uzaktan LED Göstergeli
- Boru veya Havalandırma Kısımlarındaki Duman Varlığını Tespit Eder



KONVANSİYONEL AKSESUARLAR

YKB02A

\$ 240,00

- Boru TİPİ Duman Dedektörü
- Konvansiyonel Duman Dedektörü
- Uzaktan LED Göstergeli
- Boru veya Havalandırma Kısımlarındaki Duman Varlığını Tespit Eder



KONVANSİYONEL AKSESUARLAR

YAZILIM

\$ 2.000,00

- Yangın Alarm Sistemleri Görüntüleme Arayüzü
- IFS7000 Serisi Adreslenebilir Yangın Alarm Sistemine Uygun
- FS5100, FS5200 Serisi Konvansiyonel Yangın Alarm Sistemine Uygun

KONVANSİYONEL AKSESUARLAR

AKV01 AKÜ

\$ 35,00

- 12V / 4,5Ah
- Konvansiyonel ve 1 Loop'lu Adreslenebilir Santral Uyumlu

KONVANSİYONEL AKSESUARLAR

AKV02 AKÜ

\$ 85,00

- 12V / 18Ah
- 2 ve 4 Loop'lu Adreslenebilir Santral Uyumlu

ACİL AYDINLATMA ve ACİL YÖNLENDİRME

YANGIN ALARM VE ACİL AYDINLATMA & YÖNLENDİRME SİSTEMLERİ

17120-265mm • LED'li Acil Yönlendirme Armatürü • Asma Tipi (Çift Taraflı)

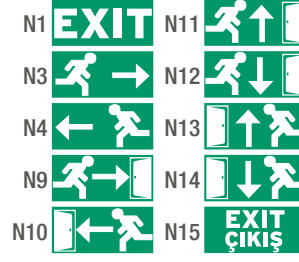
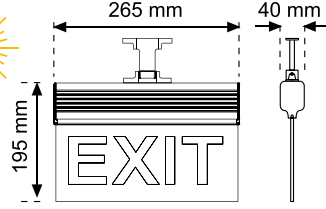

110,00 TL

Çalışma Gerilimi	Çalışma Modu	Güç Tüketimi
85-230V-50/60Hz	M	4.2W
Acilde Yanma	Kesintisiz ve Sürekli	
Acilde Yanma	Pil Türü	Çalışma Sıcaklığı
3 Saat	1x1.2V 1000mAh AA-4x4	-20°C - +40°C
Koruma Derecesi	2 YEARS GUARANTY	CE
IP 20	TS EN 60598-1	TS EN 60598-2-22
II Sınıfı		

17120-265mm ÖZEL • LED'li Acil Yönlendirme Armatürü • Asma Tipi (Çift Taraflı) • Özel tasarımı etiketler

125,00 TL

17110-265mm • LED'li Acil Yönlendirme Armatürü • Zincirle Bağlantı (Çift Taraflı)

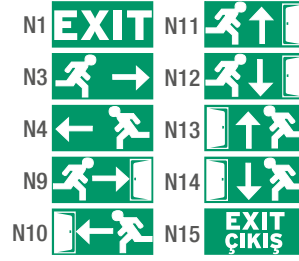
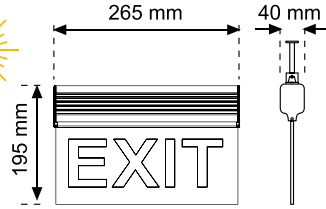

110,00 TL

Çalışma Gerilimi	Çalışma Modu	Güç Tüketimi
85-230V-50/60Hz	M	4.2W
Acilde Yanma	Kesintisiz ve Sürekli	
Acilde Yanma	Pil Türü	Çalışma Sıcaklığı
3 Saat	1x1.2V 1000mAh AA-4x4	-20°C - +40°C
Koruma Derecesi	2 YEARS GUARANTY	CE
IP 20	TS EN 60598-1	TS EN 60598-2-22
II Sınıfı		

17110-265mm ÖZEL • LED'li Acil Yönlendirme Armatürü • Zincirle Bağlantı (Çift Taraflı) • Özel tasarımı etiketler

125,00 TL

17120-305mm • LED'li Acil Yönlendirme Armatürü • Asma Tipi (Çift Taraflı)

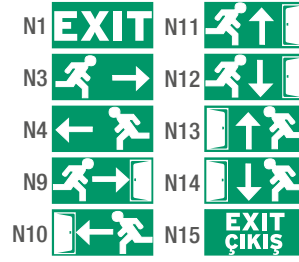
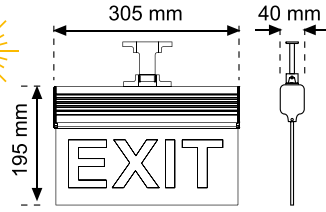

130,00 TL

Çalışma Gerilimi	Çalışma Modu	Güç Tüketimi
85-230V-50/60Hz	M	4.2W
Acilde Yanma	Kesintisiz ve Sürekli	
Acilde Yanma	Pil Türü	Çalışma Sıcaklığı
3 Saat	1x1.2V 1000mAh AA-4x4	-20°C - +40°C
Koruma Derecesi	2 YEARS GUARANTY	CE
IP 20	TS EN 60598-1	TS EN 60598-2-22
II Sınıfı		

17120-305mm ÖZEL • LED'li Acil Yönlendirme Armatürü • Asma Tipi (Çift Taraflı) • Özel tasarımı etiketler

145,00 TL

17110-305mm • LED'li Acil Yönlendirme Armatürü • Zincirle Bağlantı (Çift Taraflı)

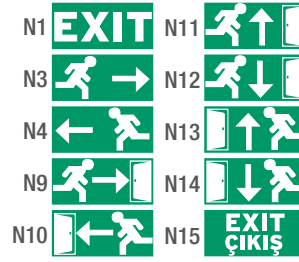
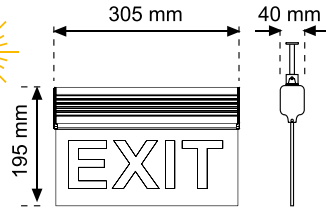

130,00 TL

Çalışma Gerilimi	Çalışma Modu	Güç Tüketimi
85-230V-50/60Hz	M	4.2W
Acilde Yanma	Kesintisiz ve Sürekli	
Acilde Yanma	Pil Türü	Çalışma Sıcaklığı
3 Saat	1x1.2V 1000mAh AA-4x4	-20°C - +40°C
Koruma Derecesi	2 YEARS GUARANTY	CE
IP 20	TS EN 60598-1	TS EN 60598-2-22
II Sınıfı		

17110-305mm ÖZEL • LED'li Acil Yönlendirme Armatürü • Zincirle Bağlantı (Çift Taraflı) • Özel tasarımı etiketler

145,00 TL

ACİL AYDINLATMA ve ACİL YÖNLENDİRME

YANGIN ALARM VE ACİL AYDINLATMA & YÖNLENDİRME SİSTEMLERİ

15036 36 LED'Lİ • Acil Aydınlatma Armatürü • Sıva üstü montaj • Acil'de yanma

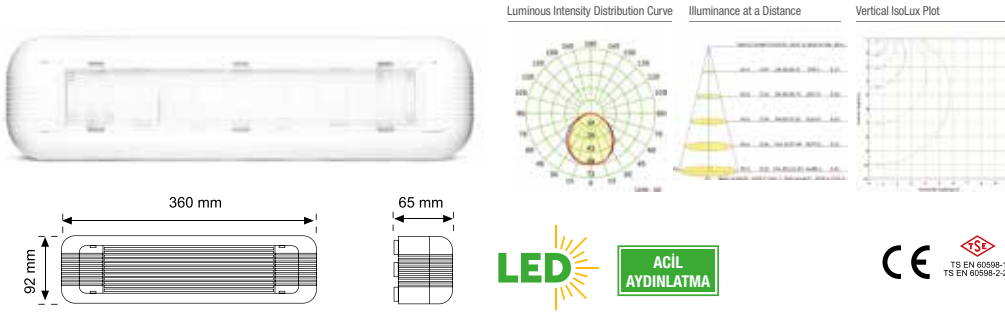

155,00 TL

Çalışma Gerilimi	Çalışma Modu	Güç Tüketimi
230-240V- 50/60Hz	NM	4W
Aydınlatma Şiddeti	Kesintide Yanar	Pil Türü
130 LM	Acilde Yanma	3x1,2V2100mAh/AA16-Ah
Çalışma Sıcaklığı	Koruma Derecesi	
-20°C ~ +40°C	IP 20	2 YEARS WARRANTY

15036 36 LED'Lİ • Acil Aydınlatma Armatürü • Sıva üstü montaj • Acil'de yanma • Acil yönlendirme etiketi

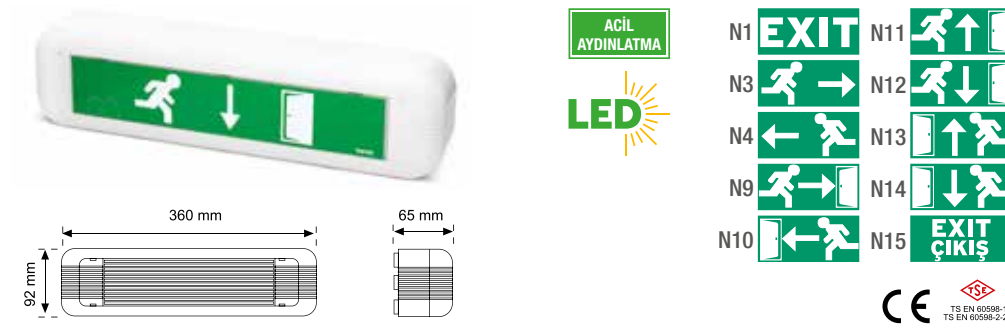

165,00 TL

Çalışma Gerilimi	Çalışma Modu	Güç Tüketimi
230-240V- 50/60Hz	NM	4W
Aydınlatma Şiddeti	Kesintide Yanar	Pil Türü
130 LM	Acilde Yanma	3x1,2V2100mAh/AA16-Ah
Çalışma Sıcaklığı	Koruma Derecesi	
-20°C ~ +40°C	IP 20	2 YEARS WARRANTY

15036 36 LED'Lİ ÖZEL • Acil Aydınlatma Armatürü • Sıva üstü montaj • Acil'de yanma • Acil yönlendirme etiketi

180,00 TL

16036 36 LED'Lİ • Acil Aydınlatma Armatürü • Sıva altı • Acil'de yanma

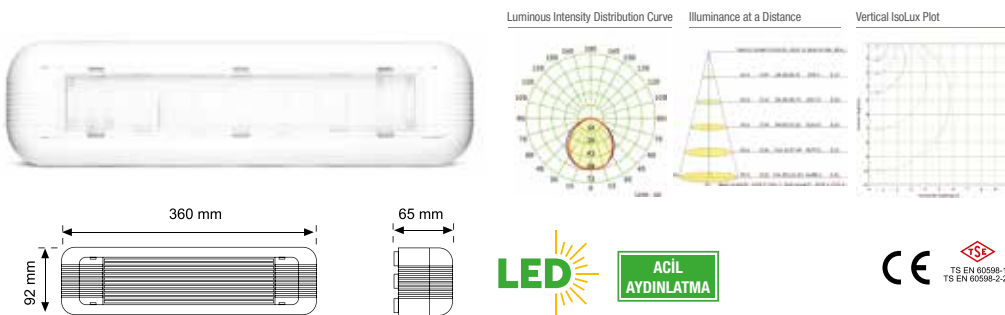

150,00 TL

Çalışma Gerilimi	Çalışma Modu	Güç Tüketimi
230-240V- 50/60Hz	NM	4W
Aydınlatma Şiddeti	Kesintide Yanar	Pil Türü
130 LM	Acilde Yanma	3x1,2V2100mAh/AA16-Ah
Çalışma Sıcaklığı	Koruma Derecesi	
-20°C ~ +40°C	IP 20	2 YEARS WARRANTY

16036 36 LED'Lİ • Acil Aydınlatma Armatürü • Sıva altı • Acil'de yanma • Acil yönlendirme etiketi

160,00 TL

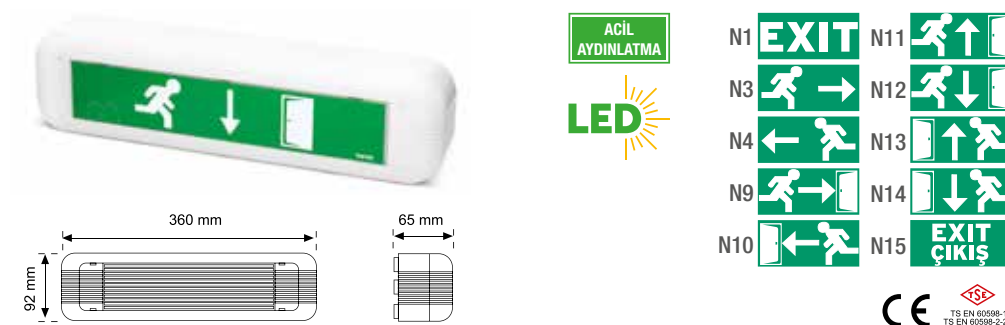

175,00 TL

16036 36 LED'Lİ ÖZEL • Acil Aydınlatma Armatürü • Sıva altı • Acil'de yanma • Acil yönlendirme etiketi

YANGIN ALGILAMA ve ACİL AYDINLATMA & YÖNLENDİRME SİSTEMLERİ

LED AYDINLATMA SİSTEMLERİ

SENSÖR ve SENSÖRLÜ AYDINLATMA SİSTEMLERİ

ACİL AYDINLATMA ve ACİL YÖNLENDİRME

YANGIN ALARM VE ACİL AYDINLATMA & YÖNLENDİRME SİSTEMLERİ

15136 36 LED'Lİ • Acil Aydınlatma Armatürü • Sıva üstü montaj • Acil'de yanma



Luminous Intensity Distribution Curve

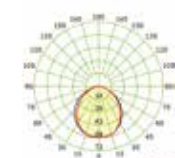

Illuminance at a Distance

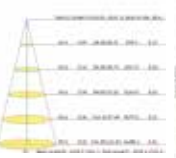

Vertical IsoLux Plot



360 mm

65 mm

92 mm

LED

ACİL AYDINLATMA

CE

TS EN 60598-1
TS EN 60598-2-22

175,00 TL

Çalışma Gerilimi	Çalışma Modu	Güç Tüketimi
230-240V~50/60Hz	M	6W
Aydınlatma Şiddeti	Kesintisiz ve Sürekli	Pil Türü
LM	Acilde Yanma	3 Saatte 2100mAh/16Ah
130 LM	3 Saat	
Çalışma Sıcaklığı	Koruma Derecesi	
-20°C ~ +40°C	IP 20	II Sınıfı
		2 YEARS WARRANTY

15136 36 LED'Lİ • Acil Aydınlatma Armatürü • Sıva üstü montaj • Acil'de yanma • Acil yönlendirme etiketi



ACİL AYDINLATMA

LED

N1 EXIT N11

N3

N4

N9

N10

N12

N13

N14

N15 EXIT ÇIKIŞ

360 mm

65 mm

92 mm

CE

TS EN 60598-1
TS EN 60598-2-22

190,00 TL

Çalışma Gerilimi	Çalışma Modu	Güç Tüketimi
230-240V~50/60Hz	M	6W
Aydınlatma Şiddeti	Kesintisiz ve Sürekli	Pil Türü
LM	Acilde Yanma	3 Saatte 2100mAh/16Ah
130 LM	3 Saat	
Çalışma Sıcaklığı	Koruma Derecesi	
-20°C ~ +40°C	IP 20	II Sınıfı
		2 YEARS WARRANTY

15136 36 LED'Lİ ÖZEL • Acil Aydınlatma Armatürü • Sıva üstü montaj • Acil'de yanma • Acil yönlendirme etiketi

16136 36 LED'Lİ • Acil Aydınlatma Armatürü • Sıva altı • Acil'de ve sürekli yanma



Luminous Intensity Distribution Curve

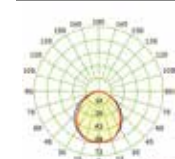

Illuminance at a Distance

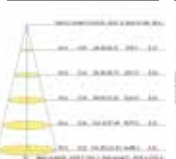

Vertical IsoLux Plot



360 mm

65 mm

92 mm

LED

ACİL AYDINLATMA

CE

TS EN 60598-1
TS EN 60598-2-22

170,00 TL

Çalışma Gerilimi	Çalışma Modu	Güç Tüketimi
230-240V~50/60Hz	M	6W
Aydınlatma Şiddeti	Kesintisiz ve Sürekli	Pil Türü
LM	Acilde Yanma	3 Saatte 2100mAh/16Ah
130 LM	3 Saat	
Çalışma Sıcaklığı	Koruma Derecesi	
-20°C ~ +40°C	IP 20	II Sınıfı
		2 YEARS WARRANTY

16136 36 LED'Lİ • Acil Aydınlatma Armatürü • Sıva altı • Acil'de ve sürekli yanma • Acil yönlendirme etiketi



ACİL AYDINLATMA

LED

N1 EXIT N11

N3

N4

N9

N10

N12

N13

N14

N15 EXIT ÇIKIŞ

360 mm

65 mm

92 mm

CE

TS EN 60598-1
TS EN 60598-2-22

185,00 TL

Çalışma Gerilimi	Çalışma Modu	Güç Tüketimi
230-240V~50/60Hz	M	6W
Aydınlatma Şiddeti	Kesintisiz ve Sürekli	Pil Türü
LM	Acilde Yanma	3 Saatte 2100mAh/16Ah
130 LM	3 Saat	
Çalışma Sıcaklığı	Koruma Derecesi	
-20°C ~ +40°C	IP 20	II Sınıfı
		2 YEARS WARRANTY

16136 36 LED'Lİ ÖZEL • Acil Aydınlatma Armatürü • Sıva altı • Acil'de ve sürekli yanma • Acil yönlendirme etiketi

200,00 TL

ACİL AYDINLATMA ve ACİL YÖNLENDİRME

YANGIN ALARM VE ACİL AYDINLATMA & YÖNLENDİRME SİSTEMLERİ

15036 48 LED'Lİ • Acil Aydınlatma Armatürü • Sıva üstü montaj • Acil'de yanma



Luminous Intensity Distribution Curve

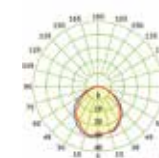

Illuminance at a Distance

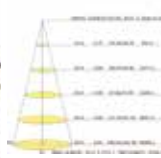

Vertical IsoLux Plot

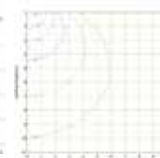

360 mm

65 mm

92 mm

LED ACİL AYDINLATMA

CE TS EN 60598-1 TS EN 60598-2-22

160,00 TL

Çalışma Gerilimi	Çalışma Modu	Güç Tüketimi
230-240V- 50/60Hz	NM	4W
Aydınlatma Şiddeti	Kesintide Yanar	Pili Türü
130 LM	Acilde Yanma	3x1,2V2100mAh/AA16-Ah
Çalışma Sıcaklığı	Koruma Derecesi	
-20°C ~ +40°C	IP 20	2 YEARS WARRANTY
	II Sınıfı	

15036 48 LED'Lİ • Acil Aydınlatma Armatürü • Sıva üstü montaj • Acil'de yanma • Acil yönlendirme etiketi



ACİL AYDINLATMA

LED

N1 EXIT N11

N3

N4

N9

N10

N12

N13

N14

N15 EXIT ÇIKIŞ

360 mm

65 mm

92 mm

CE TS EN 60598-1 TS EN 60598-2-22

175,00 TL

Çalışma Gerilimi	Çalışma Modu	Güç Tüketimi
230-240V- 50/60Hz	NM	4W
Aydınlatma Şiddeti	Kesintide Yanar	Pili Türü
130 LM	Acilde Yanma	3x1,2V2100mAh/AA16-Ah
Çalışma Sıcaklığı	Koruma Derecesi	
-20°C ~ +40°C	IP 20	2 YEARS WARRANTY
	II Sınıfı	

15036 48 LED'Lİ ÖZEL • Acil Aydınlatma Armatürü • Sıva üstü montaj • Acil'de yanma • Acil yönlendirme etiketi

190,00 TL

16036 48 LED'Lİ • Acil Aydınlatma Armatürü • Sıva altı • Acil'de yanma



Luminous Intensity Distribution Curve

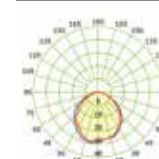

Illuminance at a Distance



Vertical IsoLux Plot

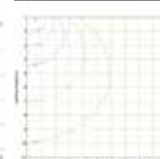

360 mm

65 mm

92 mm

LED ACİL AYDINLATMA

CE TS EN 60598-1 TS EN 60598-2-22

155,00 TL

Çalışma Gerilimi	Çalışma Modu	Güç Tüketimi
230-240V- 50/60Hz	NM	4W
Aydınlatma Şiddeti	Kesintide Yanar	Pili Türü
130 LM	Acilde Yanma	3x1,2V2100mAh/AA16-Ah
Çalışma Sıcaklığı	Koruma Derecesi	
-20°C ~ +40°C	IP 20	2 YEARS WARRANTY
	II Sınıfı	

16036 48 LED'Lİ • Acil Aydınlatma Armatürü • Sıva altı • Acil'de yanma • Acil yönlendirme etiketi



ACİL AYDINLATMA

LED

N1 EXIT N11

N3

N4

N9

N10

N12

N13

N14

N15 EXIT ÇIKIŞ

360 mm

65 mm

92 mm

CE TS EN 60598-1 TS EN 60598-2-22

170,00 TL

Çalışma Gerilimi	Çalışma Modu	Güç Tüketimi
230-240V- 50/60Hz	NM	4W
Aydınlatma Şiddeti	Kesintide Yanar	Pili Türü
130 LM	Acilde Yanma	3x1,2V2100mAh/AA16-Ah
Çalışma Sıcaklığı	Koruma Derecesi	
-20°C ~ +40°C	IP 20	2 YEARS WARRANTY
	II Sınıfı	

16036 48 LED'Lİ ÖZEL • Acil Aydınlatma Armatürü • Sıva altı • Acil'de yanma • Acil yönlendirme etiketi

185,00 TL

YANGIN ALGILAMA ve ACİL AYDINLATMA & YÖNLENDİRME SİSTEMLERİ

LED AYDINLATMA SİSTEMLERİ

SENSÖR ve SENSÖRLÜ AYDINLATMA SİSTEMLERİ

ACİL AYDINLATMA ve ACİL YÖNLENDİRME

YANGIN ALARM VE ACİL AYDINLATMA & YÖNLENDİRME SİSTEMLERİ

15136 48 LED'Lİ • Acil Aydınlatma Armatürü • Sıva üstü montaj • Acil'de yanma

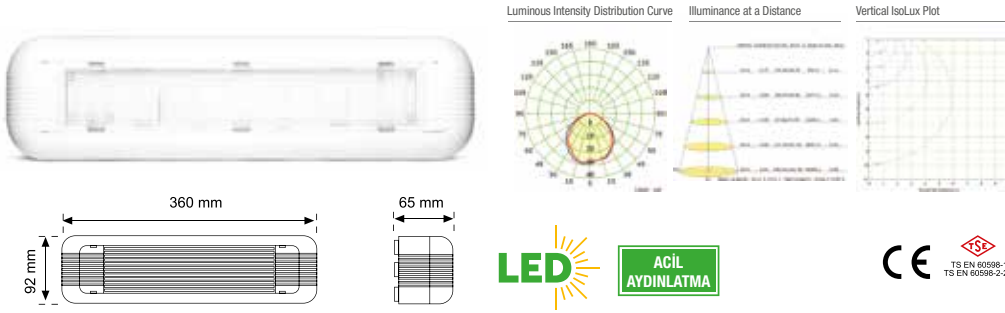

175,00 TL

Çalışma Gerilimi	Çalışma Modu	Güç Tüketimi
230-240V-50/60Hz	M	6W
Aydınlatma Şiddeti	Kesintide ve Sürekli	Pil Türü
130 LM	Acilde Yanma	3 Saatlilik
Çalışma Sıcaklığı	Koruma Derecesi	2 YIL GARANTİ
-20°C ~ +40°C	IP 20	II Sınıfı

15136 48 LED'Lİ • Acil Aydınlatma Armatürü • Sıva üstü montaj • Acil'de yanma • Acil yönlendirme etiketi

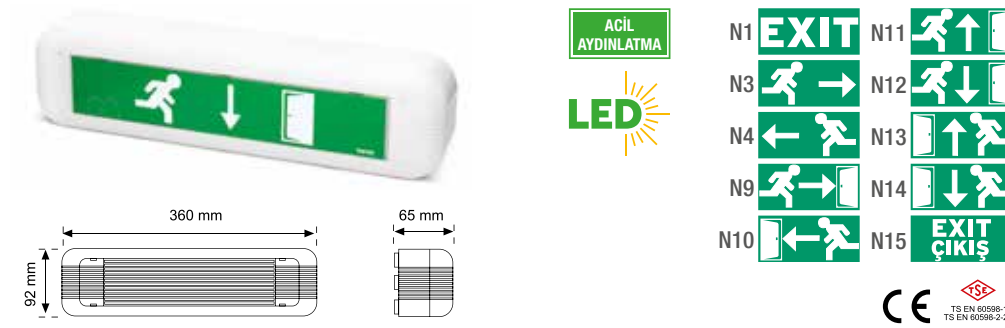

190,00 TL

Çalışma Gerilimi	Çalışma Modu	Güç Tüketimi
230-240V-50/60Hz	M	6W
Aydınlatma Şiddeti	Kesintide ve Sürekli	Pil Türü
130 LM	Acilde Yanma	3 Saatlilik
Çalışma Sıcaklığı	Koruma Derecesi	2 YIL GARANTİ
-20°C ~ +40°C	IP 20	II Sınıfı

15136 48 LED'Lİ ÖZEL • Acil Aydınlatma Armatürü • Sıva üstü montaj • Acil'de yanma • Acil yönlendirme etiketi

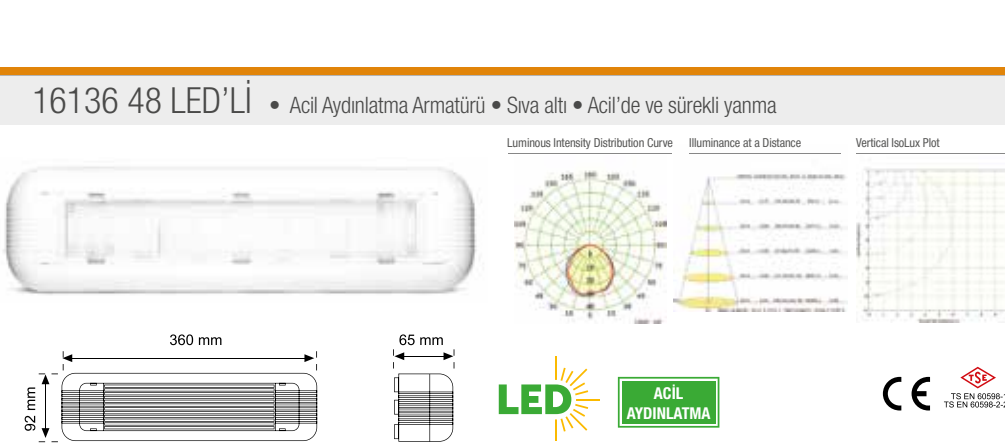

205,00 TL

Çalışma Gerilimi	Çalışma Modu	Güç Tüketimi
230-240V-50/60Hz	M	6W
Aydınlatma Şiddeti	Kesintide ve Sürekli	Pil Türü
130 LM	Acilde Yanma	3 Saatlilik
Çalışma Sıcaklığı	Koruma Derecesi	2 YIL GARANTİ
-20°C ~ +40°C	IP 20	II Sınıfı

16136 48 LED'Lİ • Acil Aydınlatma Armatürü • Sıva altı • Acil'de ve sürekli yanma



170,00 TL

Çalışma Gerilimi	Çalışma Modu	Güç Tüketimi
230-240V-50/60Hz	M	6W
Aydınlatma Şiddeti	Kesintide ve Sürekli	Pil Türü
130 LM	Acilde Yanma	3 Saatlilik
Çalışma Sıcaklığı	Koruma Derecesi	2 YIL GARANTİ
-20°C ~ +40°C	IP 20	II Sınıfı

16136 48 LED'Lİ ÖZEL • Acil Aydınlatma Armatürü • Sıva altı • Acil'de ve sürekli yanma • Acil yönlendirme etiketi

185,00 TL

Çalışma Gerilimi	Çalışma Modu	Güç Tüketimi
230-240V-50/60Hz	M	6W
Aydınlatma Şiddeti	Kesintide ve Sürekli	Pil Türü
130 LM	Acilde Yanma	3 Saatlilik
Çalışma Sıcaklığı	Koruma Derecesi	2 YIL GARANTİ
-20°C ~ +40°C	IP 20	II Sınıfı

ACİL AYDINLATMA ve ACİL YÖNLENDİRME

YANGIN ALARM VE ACİL AYDINLATMA & YÖNLENDİRME SİSTEMLERİ

20024 24 LED'Lİ • Acil Aydınlatma Armatürü • Acil'de yanma 2 saat

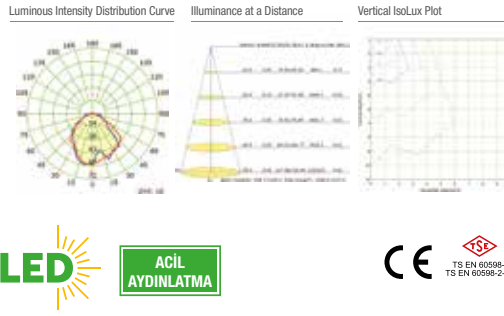
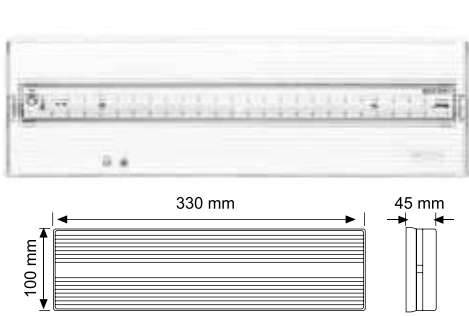

130,00 TL

Çalışma Gerilimi	Çalışma Modu	Güç Tüketimi
85-265V - 50/60Hz	NM	2.8W
Aydınlatma Şiddeti	Kesintide Yanma	Pil Türü
LM	Acilde Yanma	4.8V 1000 mAh Ni-Mh
128 LM	2 Saat	
Çalışma Sıcaklığı	Koruma Derecesi	
-20°C ~ +40°C	IP 20	2 YEARS WARRANTY

20024 24 LED'Lİ • Acil Aydınlatma Armatürü • Acil'de yanma 2 saat • Acil yönlendirme etiketi

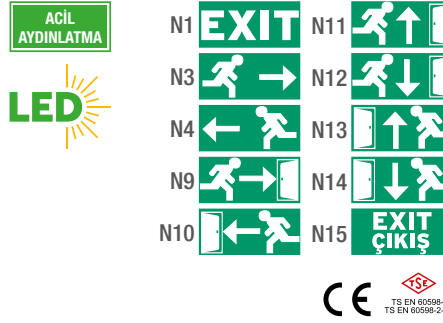
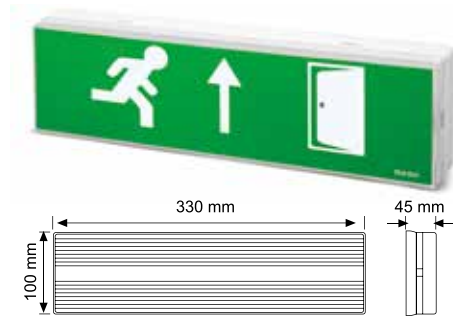

145,00 TL

Çalışma Gerilimi	Çalışma Modu	Güç Tüketimi
85-265V - 50/60Hz	NM	2.8W
Aydınlatma Şiddeti	Kesintide Yanma	Pil Türü
LM	Acilde Yanma	4.8V 1000 mAh Ni-Mh
128 LM	2 Saat	
Çalışma Sıcaklığı	Koruma Derecesi	
-20°C ~ +40°C	IP 20	2 YEARS WARRANTY

20024 24 LED'Lİ ÖZEL • Acil Aydınlatma Armatürü • Acil'de yanma 2 saat • Özel tasarım etiketler

160,00 TL

20124 24 LED'Lİ • Acil Aydınlatma Armatürü • Acil'de ve sürekli 2 saat • 130 Lm

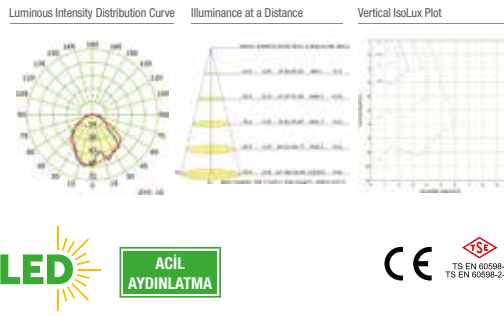
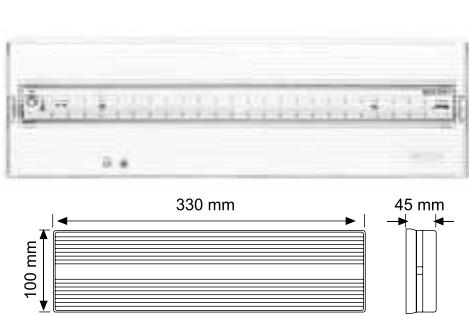

150,00 TL

Çalışma Gerilimi	Çalışma Modu	Güç Tüketimi
85-265V - 50/60Hz	M	5.5W
Aydınlatma Şiddeti	Kesintide ve Sürekli	Pil Türü
LM	Acilde Yanma	4.8V 1000 mAh Ni-Mh
128 LM	2 Saat	
Çalışma Sıcaklığı	Koruma Derecesi	
-20°C ~ +40°C	IP 20	2 YEARS WARRANTY

20124 24 LED'Lİ • Acil Aydınlatma Armatürü • Acil'de ve sürekli 2 saat • Acil yönlendirme etiketi

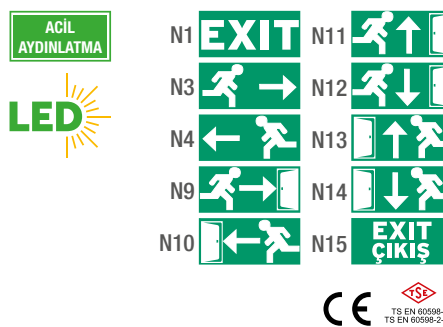

165,00 TL

Çalışma Gerilimi	Çalışma Modu	Güç Tüketimi
85-265V - 50/60Hz	M	5.5W
Aydınlatma Şiddeti	Kesintide ve Sürekli	Pil Türü
LM	Acilde Yanma	4.8V 1000 mAh Ni-Mh
128 LM	2 Saat	
Çalışma Sıcaklığı	Koruma Derecesi	
-20°C ~ +40°C	IP 20	2 YEARS WARRANTY

20124 24 LED'Lİ ÖZEL • Acil Aydınlatma Armatürü • Acil'de ve sürekli 2 saat • Özel tasarım etiketler

180,00 TL

YANGIN ALGILAMA ve ACİL AYDINLATMA & YÖNLENDİRME SİSTEMLERİ

LED AYDINLATMA SİSTEMLERİ

SENSÖR ve SENSÖRLÜ AYDINLATMA SİSTEMLERİ

ACİL AYDINLATMA ve ACİL YÖNLENDİRME

YANGIN ALARM VE ACİL AYDINLATMA & YÖNLENDİRME SİSTEMLERİ

20024 48 LED'Lİ • Acil Aydınlatma Armatürü • Acil'de yanma 2 saat • 150 Lm



Luminous Intensity Distribution Curve

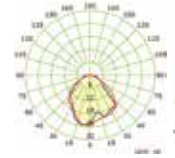

Illuminance at a Distance

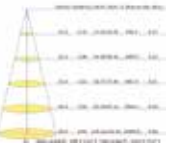

Vertical IsoLux Plot

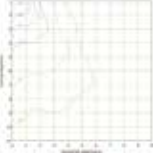

330 mm

45 mm

100 mm

LED

ACİL AYDINLATMA

CE

TS EN 60598-1
TS EN 60598-2-22

140,00 TL

Çalışma Gerilimi	Çalışma Modu	Güç Tüketimi
85-265V - 50/60Hz	NM	2.8W
Aydınlatma Şiddeti	Kesintide Yanar	Pil Türü
128 LM	Acilde Yanma	4.8V 1000 mAh Ni-Mh
Çalışma Sıcaklığı	Koruma Derecesi	2 YEARS WARRANTY
-20°C ~ +40°C	IP 20	II Sınıfı

20024 48 LED'Lİ • Acil Aydınlatma Armatürü • Acil'de yanma 2 saat • Acil yönlendirme etiketi



330 mm

45 mm

100 mm

LED

ACİL AYDINLATMA

N1 EXIT N11

N3 N12

N4 N13

N9 N14

N10 N15 EXIT ÇIKIŞ

CE

TS EN 60598-1
TS EN 60598-2-22

155,00 TL

Çalışma Gerilimi	Çalışma Modu	Güç Tüketimi
85-265V - 50/60Hz	NM	2.8W
Aydınlatma Şiddeti	Kesintide Yanar	Pil Türü
128 LM	Acilde Yanma	4.8V 1000 mAh Ni-Mh
Çalışma Sıcaklığı	Koruma Derecesi	2 YEARS WARRANTY
-20°C ~ +40°C	IP 20	II Sınıfı

20024 48 LED'Lİ ÖZEL • Acil Aydınlatma Armatürü • Acil'de yanma 2 saat • Özel tasarım etiketler

170,00 TL

20124 48 LED'Lİ • Acil Aydınlatma Armatürü • Acil'de ve sürekli • 5W • 150 Lm



Luminous Intensity Distribution Curve

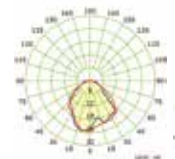

Illuminance at a Distance



Vertical IsoLux Plot

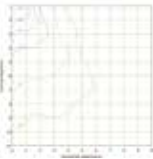

330 mm

45 mm

100 mm

LED

ACİL AYDINLATMA

CE

TS EN 60598-1
TS EN 60598-2-22

160,00 TL

Çalışma Gerilimi	Çalışma Modu	Güç Tüketimi
85-265V - 50/60Hz	M	5.5W
Aydınlatma Şiddeti	Kesintide ve Sürekli	Pil Türü
128 LM	Acilde Yanma	4.8V 1000 mAh Ni-Mh
Çalışma Sıcaklığı	Koruma Derecesi	2 YEARS WARRANTY
-20°C ~ +40°C	IP 20	II Sınıfı

20124 48 LED'Lİ • Acil Aydınlatma Armatürü • Acil'de ve sürekli 2 saat • Acil yönlendirme etiketli



330 mm

45 mm

100 mm

LED

ACİL AYDINLATMA

N1 EXIT N11

N3 N12

N4 N13

N9 N14

N10 N15 EXIT ÇIKIŞ

CE

TS EN 60598-1
TS EN 60598-2-22

175,00 TL

Çalışma Gerilimi	Çalışma Modu	Güç Tüketimi
85-265V - 50/60Hz	M	5.5W
Aydınlatma Şiddeti	Kesintide ve Sürekli	Pil Türü
128 LM	Acilde Yanma	4.8V 1000 mAh Ni-Mh
Çalışma Sıcaklığı	Koruma Derecesi	2 YEARS WARRANTY
-20°C ~ +40°C	IP 20	II Sınıfı

20124 48 LED'Lİ ÖZEL • Acil Aydınlatma Armatürü • Acil'de ve sürekli 2 saat • Özel tasarım etiketler

190,00 TL

ACİL AYDINLATMA ve ACİL YÖNLENDİRME

YANGIN ALARM VE ACİL AYDINLATMA & YÖNLENDİRME SİSTEMLERİ

17000

25,00 TL



ACİL
AYDINLATMA



CE

• LED'li acil yönlendirme armatürleri sıva altı aparatı

17001

40,00 TL



ACİL
AYDINLATMA



CE

• LED'li acil yönlendirme armatürleri sıva altı aparatı

17002

40,00 TL



ACİL
AYDINLATMA



CE

• LED'li acil yönlendirme armatürleri sıva altı aparatı

19141

25,00 TL

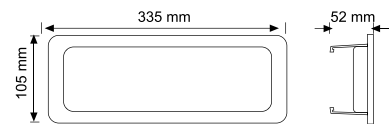

ACİL
AYDINLATMA



CE

• LED'li acil yönlendirme armatürleri sıva altı aparatı

ACİL AYDINLATMA ve ACİL YÖNLENDİRME

YANGIN ALARM VE ACİL AYDINLATMA & YÖNLENDİRME SİSTEMLERİ

19145

60,00 TL

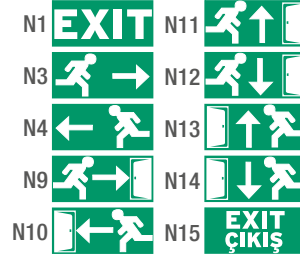

ACİL AYDINLATMA



CE

- Acil aydınlatma armatürleri siva altı aparatı

19145

75,00 TL

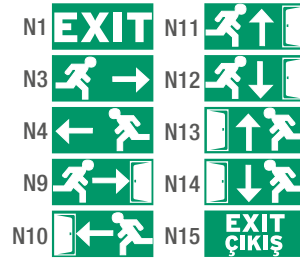

ACİL AYDINLATMA



CE

- Acil aydınlatma armatürleri siva altı aparatı
- Özel tasarım etiketler



LED AYDINLATMA SİSTEMLERİ

LED AYDINLATMA SİSTEMLERİ

na·De®

SENSÖR ve SENSÖRLÜ
AYDINLATMA SİSTEMLERİ

ANCHALIGHTING®
LED AYDINLATMA SİSTEMLERİ

CAPELLA



ANCHALIGHTING®

LED AYDINLATMA SİSTEMLERİ

CAPELLA

HD009 3" LED DOWNLIGHT



SIVA ALTI

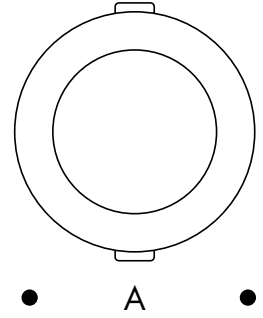

KOD	(V)	(W)	Lümen	Kelvin	IP	Güç Ünitesi	A (mm)	Kesim Ölçüsü (mm)	Kasa Rengi	FİYAT (USD)
101.01.1113	220V	9W	850	3000K	40	VAR	Ø117	Ø80	BEYAZ	\$ 24,00
101.01.1114	220V	9W	850	4000K	40	VAR	Ø117	Ø80	BEYAZ	\$ 24,00
101.01.1116	220V	9W	850	6500K	40	VAR	Ø117	Ø80	BEYAZ	\$ 24,00

- Alüminyum gövde
- PC/PMMA difüzör seçeneği
- IP40 koruma sınıfı
- NA-DE LED Driver

Luminous Intensity Distribution Curve

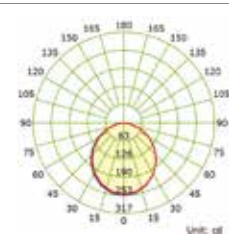

Illuminance at a Distance

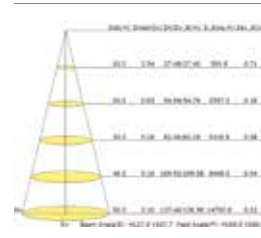

Vertical IsoLux Plot

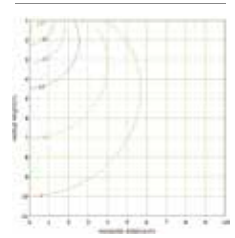

ANCHALIGHTING®

LED AYDINLATMA SİSTEMLERİ

CAPELLA

HD012 4" LED DOWNLIGHT



SIVA ALTI

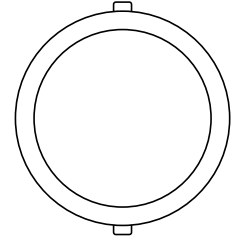

● A ●

KOD	(V)	(W)	Lümen	Kelvin	IP	Güç Ünitesi	A (mm)	Kesim Ölçüsü (mm)	Kasa Rengi	FİYAT (USD)
101.02.1113	220V	12W	1100	3000K	40	VAR	Ø147	Ø125	BEYAZ	\$ 30,00
101.02.1114	220V	12W	1100	4000K	40	VAR	Ø147	Ø125	BEYAZ	\$ 30,00
101.02.1116	220V	12W	1100	6500K	40	VAR	Ø147	Ø125	BEYAZ	\$ 30,00

- Alüminyum gövde
- PC/PMMA difüzör seçeneği
- IP40 koruma sınıfı
- NA-DE LED Driver

Luminous Intensity Distribution Curve

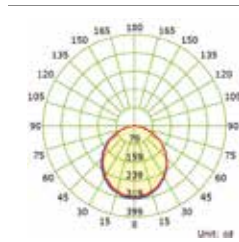

Illuminance at a Distance

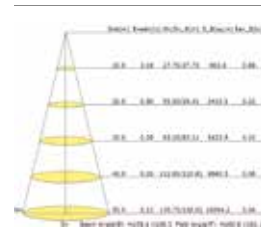

Vertical IsoLux Plot

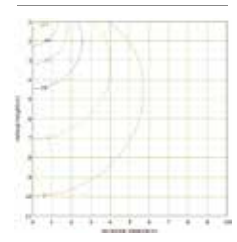

LED 220 V 50Hz IP40 50.000h CRI 80 PC/PMMA OPAL DIFÜZÖR AL ALÜMİNYUM GÖVDE SIVA ALTI MONTAJ



ANCHALIGHTING®

LED AYDINLATMA SİSTEMLERİ

CAPELLA

HD015 5" LED DOWNLIGHT



SIVA ALTI

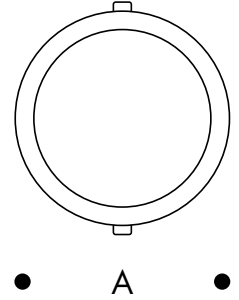

KOD	(V)	(W)	Lümen	Kelvin	IP	Güç Ünitesi	A (mm)	Kesim Ölçüsü (mm)	Kasa Rengi	FİYAT (USD)
101.03.1113	220V	15W	1300	3000K	40	VAR	Ø175	Ø155	BEYAZ	\$ 34,00
101.03.1114	220V	15W	1300	4000K	40	VAR	Ø175	Ø155	BEYAZ	\$ 34,00
101.03.1116	220V	15W	1300	6500K	40	VAR	Ø175	Ø155	BEYAZ	\$ 34,00

- Alüminyum gövde
- PC/PMMA difüzör seçeneği
- IP40 koruma sınıfı
- NA-DE LED Driver

Luminous Intensity Distribution Curve

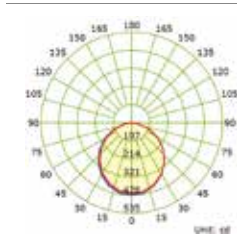

Illuminance at a Distance

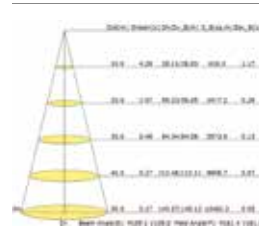

Vertical IsoLux Plot

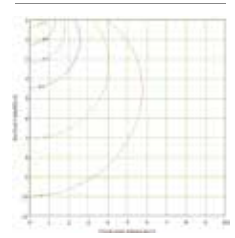

ANCHALIGHTING®

LED AYDINLATMA SİSTEMLERİ

CAPELLA

HD018 6" LED DOWNLIGHT



SIVA ALTI

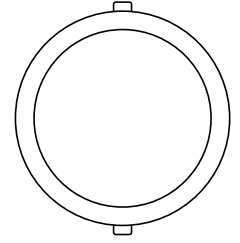

● A ●

KOD	(V)	(W)	Lümen	Kelvin	IP	Güç Ünitesi	A (mm)	Kesim Ölçüsü (mm)	Kasa Rengi	FİYAT (USD)
101.04.1113	220V	18W	1450	3000K	40	VAR	Ø190	Ø175	BEYAZ	\$ 39,00
101.04.1114	220V	18W	1450	4000K	40	VAR	Ø190	Ø175	BEYAZ	\$ 39,00
101.04.1116	220V	18W	1450	6500K	40	VAR	Ø190	Ø175	BEYAZ	\$ 39,00

- Alüminyum gövde
- PC/PMMA difüzör seçeneği
- IP40 koruma sınıfı
- NA-DE LED Driver

Luminous Intensity Distribution Curve

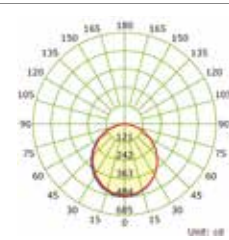

Illuminance at a Distance

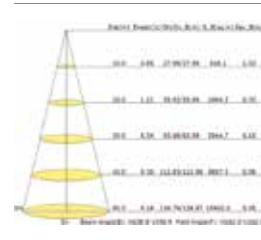

Vertical IsoLux Plot

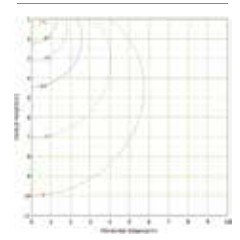

LED	220 V 50Hz	IP40	50.000h	CRI 80	PC/PMMA OPAL DİFÜZÖR	AL ALÜMİNYUM GÖVDE	SIVA ALTI MONTAJ				CE
-----	---------------	------	---------	--------	----------------------------	--------------------------	---------------------	--	--	--	----



ANCHALIGHTING®

LED AYDINLATMA SİSTEMLERİ

CAPELLA

HD024 8" LED DOWNLIGHT



SIVA ALTI

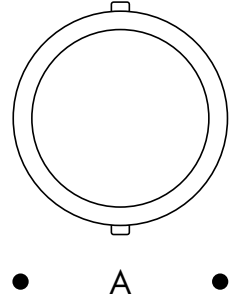

KOD	(V)	(W)	Lümen	Kelvin	IP	Güç Ünitesi	A (mm)	Kesim Ölçüsü (mm)	Kasa Rengi	FİYAT (USD)
101.05.1113	220V	24W	2300	3000K	40	VAR	Ø227	Ø210	BEYAZ	\$ 62,00
101.05.1114	220V	24W	2300	4000K	40	VAR	Ø227	Ø210	BEYAZ	\$ 62,00
101.05.1116	220V	24W	2300	6500K	40	VAR	Ø227	Ø210	BEYAZ	\$ 62,00

- Alüminyum gövde
- PC/PMMA difüzör seçeneği
- IP40 koruma sınıfı
- NA-DE LED Driver

Luminous Intensity Distribution Curve

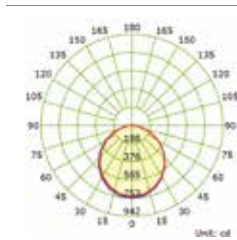

Illuminance at a Distance

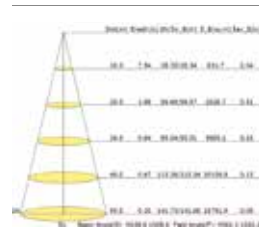

Vertical IsoLux Plot

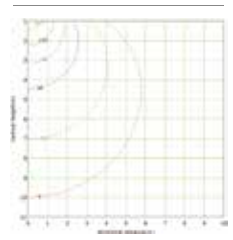

ANCHALIGHTING®

LED AYDINLATMA SİSTEMLERİ

CAPELLA

SD003 LED DOWNLIGHT



SIVA ALTI

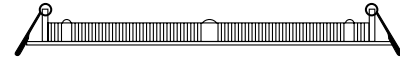
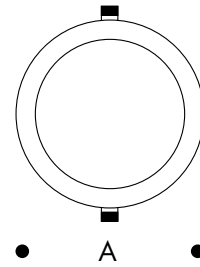

KOD	(V)	(W)	Lümen	Kelvin	IP	Güç Ünitesi	A (mm)	B (mm)	Kesim Ölçüsü (mm)	Kasa Rengi	FİYAT (USD)
101.06.1113	130-265V	3W	180	3000K	23	VAR	Ø90	12	Ø76	BEYAZ	\$ 2,80
101.06.1114	130-265V	3W	180	4000K	23	VAR	Ø90	12	Ø76	BEYAZ	\$ 2,80
101.06.1116	130-265V	3W	180	6500K	23	VAR	Ø90	12	Ø76	BEYAZ	\$ 2,80

- Alüminyum gövde
- PMMA LGP
- PC/PMMA difüzör seçeneği
- IP23 koruma sınıfı
- NA-DE LED Driver

Luminous Intensity Distribution Curve

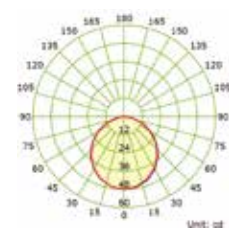

Illuminance at a Distance

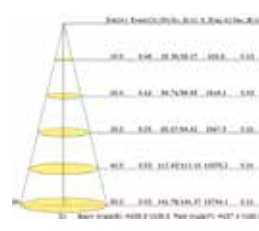

Vertical IsoLux Plot

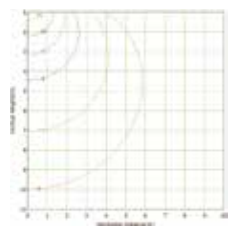

ANCHALIGHTING®

LED AYDINLATMA SİSTEMLERİ

CAPELLA

SD006 LED DOWNLIGHT



SIVA ALTI

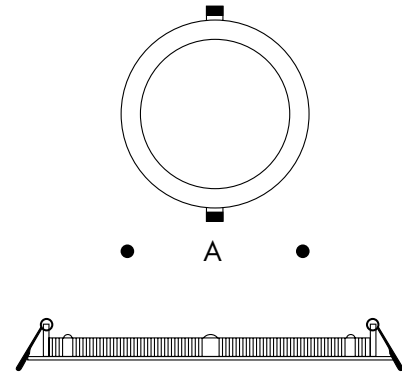

KOD	(V)	(W)	Lümen	Kelvin	IP	Güç Ünitesi	A (mm)	B (mm)	Kesim Ölçüsü (mm)	Kasa Rengi	FİYAT (USD)
101.07.1113	110-265V	6W	470	3000K	23	VAR	Ø123	12	Ø110	BEYAZ	\$ 4,50
101.07.1114	110-265V	6W	470	4000K	23	VAR	Ø123	12	Ø110	BEYAZ	\$ 4,50
101.07.1116	110-265V	6W	470	6500K	23	VAR	Ø123	12	Ø110	BEYAZ	\$ 4,50

- Alüminyum gövde
- PMMA LGP
- PC/PMMA difüzör seçeneği
- IP23 koruma sınıfı
- NA-DE LED Driver

Luminous Intensity Distribution Curve

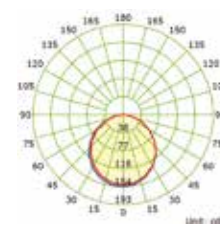

Illuminance at a Distance

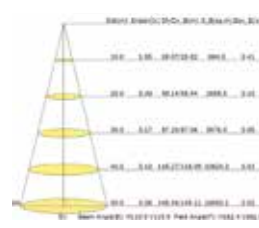

Vertical IsoLux Plot

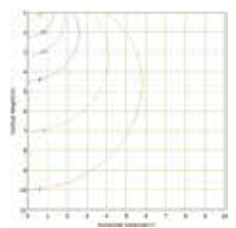

ANCHALIGHTING®

LED AYDINLATMA SİSTEMLERİ

CAPELLA

SD009 LED DOWNLIGHT



SIVA ALTI

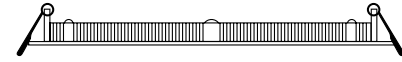
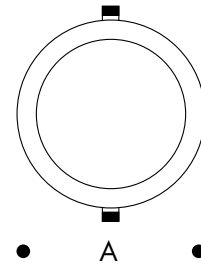

KOD	(V)	(W)	Lümen	Kelvin	IP	Güç Ünitesi	A (mm)	B (mm)	Kesim Ölçüsü (mm)	Kasa Rengi	FİYAT (USD)
101.08.1113	110-265V	9W	700	3000K	23	VAR	Ø147	12	Ø135	BEYAZ	\$ 5,30
101.08.1114	110-265V	9W	700	4000K	23	VAR	Ø147	12	Ø135	BEYAZ	\$ 5,30
101.08.1116	110-265V	9W	700	6500K	23	VAR	Ø147	12	Ø135	BEYAZ	\$ 5,30

- Alüminyum gövde
- PMMA LGP
- PC/PMMA difüzör seçeneği
- IP23 koruma sınıfı
- NA-DE LED Driver

Luminous Intensity Distribution Curve

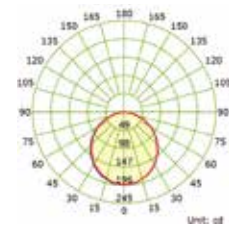

Illuminance at a Distance

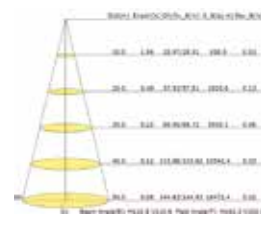

Vertical IsoLux Plot

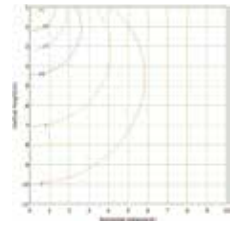

LED	110-265 V 50Hz	IP23	50.000h	CRI 80	PC/PMMA OPAL DİFÜZÖR	AL ALÜMİNYUM GÖVDE	SIVA ALTI MONTAJ	CE
-----	-------------------	------	---------	--------	----------------------------	--------------------------	---------------------	----



ANCHALIGHTING®

LED AYDINLATMA SİSTEMLERİ

CAPELLA

SD012 LED DOWNLIGHT



SIVA ALTI

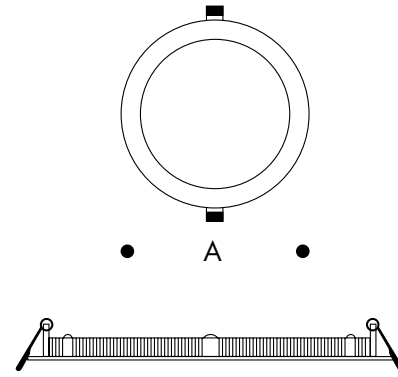

KOD	(V)	(W)	Lümen	Kelvin	IP	Güç Ünitesi	A (mm)	B (mm)	Kesim Ölçüsü (mm)	Kasa Rengi	FİYAT (USD)
101.09.1113	110-265V	12W	870	3000K	23	VAR	Ø170	12	Ø160	BEYAZ	\$ 6,00
101.09.1114	110-265V	12W	870	4000K	23	VAR	Ø170	12	Ø160	BEYAZ	\$ 6,00
101.09.1116	110-265V	12W	870	6500K	23	VAR	Ø170	12	Ø160	BEYAZ	\$ 6,00

- Alüminyum gövde
- PMMA LGP
- PC/PMMA difüzör seçeneği
- IP23 koruma sınıfı
- NA-DE LED Driver

Luminous Intensity Distribution Curve

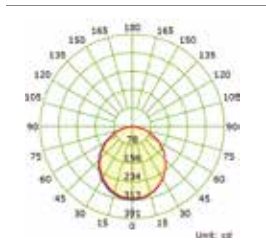

Illuminance at a Distance

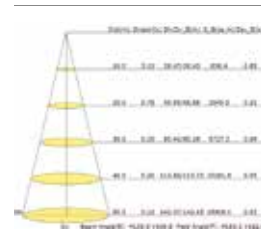

Vertical IsoLux Plot

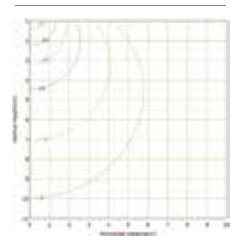

ANCHALIGHTING®

LED AYDINLATMA SİSTEMLERİ

CAPELLA

SD015 LED DOWNLIGHT



SIVA ALTI

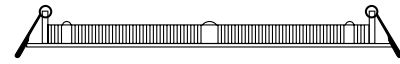
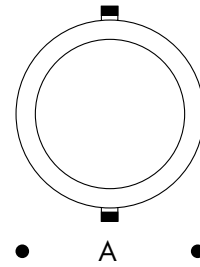

KOD	(V)	(W)	Lümen	Kelvin	IP	Güç Ünitesi	A (mm)	B (mm)	Kesim Ölçüsü (mm)	Kasa Rengi	FİYAT (USD)
101.10.1113	110-265V	15W	1050	3000K	23	VAR	Ø199	12	Ø185	BEYAZ	\$ 6,50
101.10.1114	110-265V	15W	1050	4000K	23	VAR	Ø199	12	Ø185	BEYAZ	\$ 6,50
101.10.1116	110-265V	15W	1050	6500K	23	VAR	Ø199	12	Ø185	BEYAZ	\$ 6,50

- Alüminyum gövde
- PMMA LGP
- PC/PMMA difüzör seçeneği
- IP23 koruma sınıfı
- NA-DE LED Driver

Luminous Intensity Distribution Curve

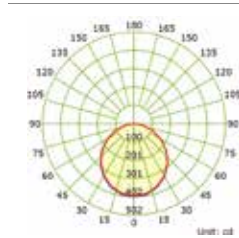

Illuminance at a Distance

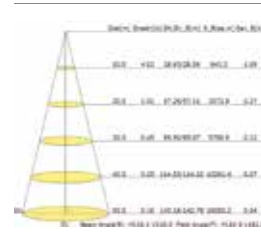

Vertical IsoLux Plot

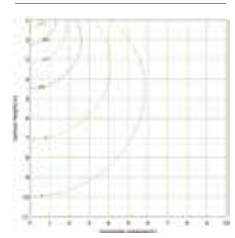

LED	110-265 V 50Hz	IP23	50.000h	CRI 80	PC/PMMA OPAL DİFÜZÖR	AL ALÜMİNYUM GÖVDE	SIVA ALTI MONTAJ	CE
-----	-------------------	------	---------	--------	----------------------------	--------------------------	---------------------	----



ANCHALIGHTING®

LED AYDINLATMA SİSTEMLERİ

CAPELLA

SD018 LED DOWNLIGHT



SIVA ALTI

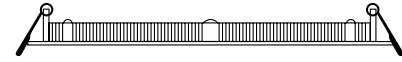
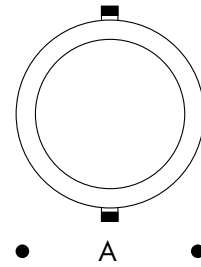

KOD	(V)	(W)	Lümen	Kelvin	IP	Güç Ünitesi	A (mm)	B (mm)	Kesim Ölçüsü (mm)	Kasa Rengi	FİYAT (USD)
101.11.1113	110-265V	18W	1350	3000K	23	VAR	Ø220	12	Ø210	BEYAZ	\$ 7,50
101.11.1114	110-265V	18W	1350	4000K	23	VAR	Ø220	12	Ø210	BEYAZ	\$ 7,50
101.11.1116	110-265V	18W	1350	6500K	23	VAR	Ø220	12	Ø210	BEYAZ	\$ 7,50

- Alüminyum gövde
- PMMA LGP
- PC/PMMA difüzör seçeneği
- IP23 koruma sınıfı
- NA-DE LED Driver

Luminous Intensity Distribution Curve

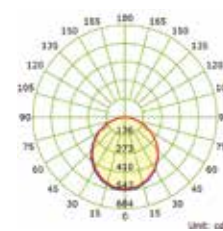

Illuminance at a Distance

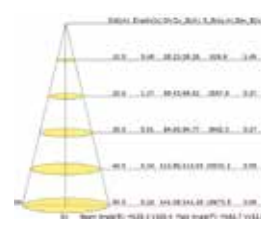

Vertical IsoLux Plot

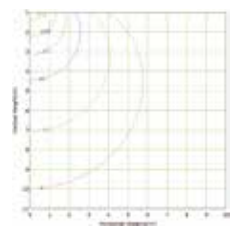

ANCHALIGHTING®

LED AYDINLATMA SİSTEMLERİ

CAPELLA

MINI 4" LED DOWNLIGHT



SIVA ALTI

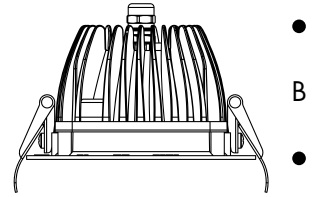
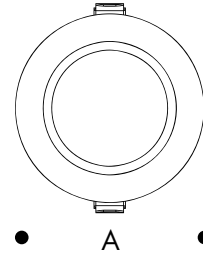

KOD	(V)	(W)	Lümen	Kelvin	IP	Güç Ünitesi	A (mm)	B (mm)	Kesim Ölçüsü (mm)	Kasa Rengi	FİYAT (USD)
101.12.1113	220V	10W	700	3000K	44	VAR	Ø122	72	Ø105	BEYAZ	\$ 21,00
101.12.1114	220V	10W	700	4000K	44	VAR	Ø122	72	Ø105	BEYAZ	\$ 21,00
101.12.1116	220V	10W	700	6500K	44	VAR	Ø122	72	Ø105	BEYAZ	\$ 21,00

- Alüminyum gövde
- PC/PMMA difüzör seçeneği
- IP44 koruma sınıfı

Luminous Intensity Distribution Curve

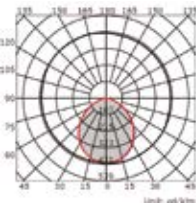

Illuminance at a Distance

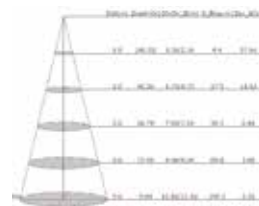

Vertical IsoLux Plot

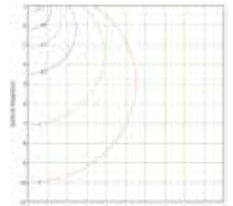

ANCHALIGHTING®

LED AYDINLATMA SİSTEMLERİ

CAPELLA

MIDI 6" LED DOWNLIGHT



SIVA ALTI

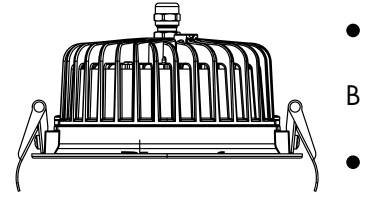
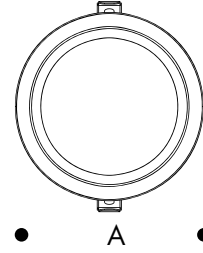

KOD	(V)	(W)	Lümen	Kelvin	IP	Güç Ünitesi	A (mm)	B (mm)	Kesim Ölçüsü (mm)	Kasa Rengi	FİYAT (USD)
101.13.1113	220V	14W	1300	3000K	44	VAR	Ø160	70	Ø147	BEYAZ	\$ 25,00
101.13.1114	220V	14W	1300	4000K	44	VAR	Ø160	70	Ø147	BEYAZ	\$ 25,00
101.13.1116	220V	14W	1300	6500K	44	VAR	Ø160	70	Ø147	BEYAZ	\$ 25,00

- Alüminyum gövde
- PC/PMMA difüzör seçeneği
- IP44 koruma sınıfı

Luminous Intensity Distribution Curve

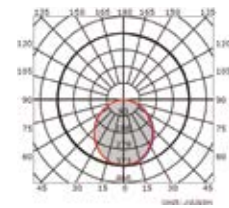

Illuminance at a Distance

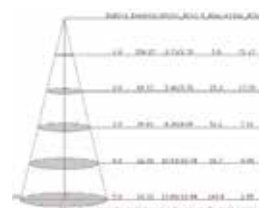

Vertical IsoLux Plot

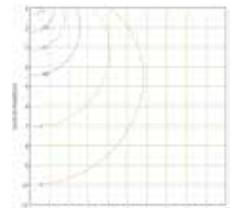

LED 220 V 50Hz IP44 50.000h CRI 80 PC/PMMA OPAL DİFÜZÖR AL ALÜMİNYUM GÖVDE SIVA ALTI MONTAJ



ANCHALIGHTING®

LED AYDINLATMA SİSTEMLERİ

CAPELLA

MAXI 7" LED DOWNLIGHT



SIVA ALTI

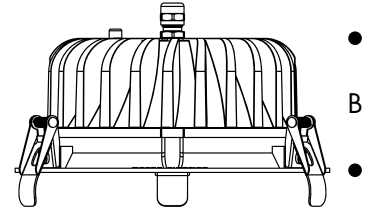
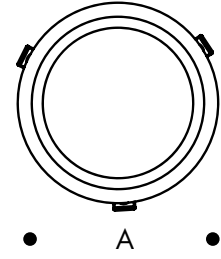

KOD	(V)	(W)	Lümen	Kelvin	IP	Güç Ünitesi	A (mm)	B (mm)	Kesim Ölçüsü (mm)	Kasa Rengi	FİYAT (USD)
101.14.1113	220V	21W	1600	3000K	44	VAR	Ø188	85	Ø175	BEYAZ	\$ 28,00
101.14.1114	220V	21W	1600	4000K	44	VAR	Ø188	85	Ø175	BEYAZ	\$ 28,00
101.14.1116	220V	21W	1600	6500K	44	VAR	Ø188	85	Ø175	BEYAZ	\$ 28,00

- Alüminyum gövde
- PC/PMMA difüzör seçeneği
- IP44 koruma sınıfı

Luminous Intensity Distribution Curve

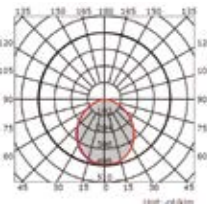

Illuminance at a Distance

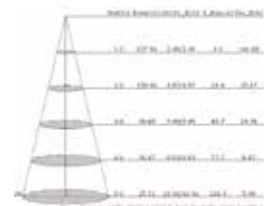

Vertical IsoLux Plot

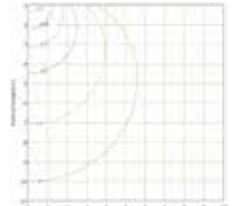

LED 220 V 50Hz IP44 50.000h CRI 80 PC/PMMA OPAL DIFÜZÖR AL ALÜMİNYUM GÖVDE SIVA ALTI MONTAJ



ANCHALIGHTING®
LED AYDINLATMA SİSTEMLERİ

MEISSA



LED AYDINLATMA SİSTEMLERİ

SENSÖR ve SENSÖRLÜ
AYDINLATMA SİSTEMLERİ

ANCHALIGHTING®

LED AYDINLATMA SİSTEMLERİ

MEISSA

30x30 SIVA ALTI BACKLIGHT LED PANEL



SIVA ALTI

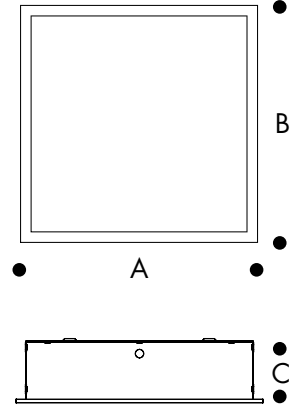

KOD	(V)	(W)	Lümen	Kelvin	IP	Güç Ünitesi	A (mm)	B (mm)	C (mm)	Kesim Ölçüsü (mm)	Kasa Rengi	FİYAT (USD)
102.02.3113	220V	12W	950	3000K	40	VAR	295	295	65	275x275	BEYAZ	\$ 36,00
102.02.3114	220V	12W	950	4000K	40	VAR	295	295	65	275x275	BEYAZ	\$ 36,00
102.02.3116	220V	12W	950	6500K	40	VAR	295	295	65	275x275	BEYAZ	\$ 36,00

- DKP Sac gövde
- Alüminyum çerçeve
- Opal PC/PMMA difüzör
- IP40 koruma sınıfı

Luminous Intensity Distribution Curve

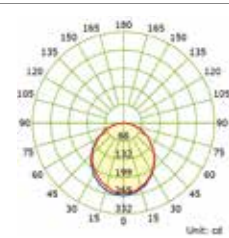

Illuminance at a Distance

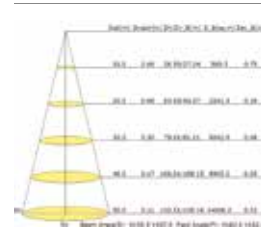

Vertical IsoLux Plot

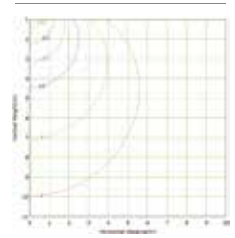

ANCHALIGHTING®

LED AYDINLATMA SİSTEMLERİ

MEISSA

30x30 SIVA ÜSTÜ LED PANEL



SIVA ÜSTÜ

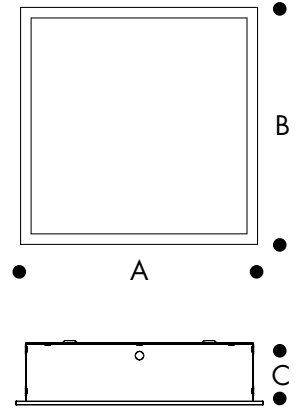

KOD	(V)	(W)	Lümen	Kelvin	IP	Güç Ünitesi	A (mm)	B (mm)	C (mm)	Kesim Ölçüsü (mm)	Kasa Rengi	FİYAT (USD)
102.10.3113	220V	12W	950	3000K	40	VAR	295	295	65	275x275	BEYAZ	\$ 36,00
102.10.3114	220V	12W	950	4000K	40	VAR	295	295	65	275x275	BEYAZ	\$ 36,00
102.10.3116	220V	12W	950	6500K	40	VAR	295	295	65	275x275	BEYAZ	\$ 36,00

- DKP Sac gövde
- Alüminyum çerçeve
- Opal PC/PMMA difüzör
- IP40 koruma sınıfı

Luminous Intensity Distribution Curve

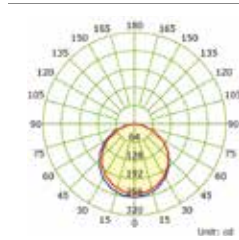

Illuminance at a Distance

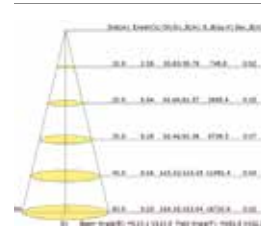

Vertical IsoLux Plot

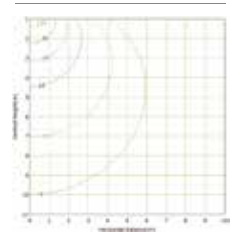

ANCHALIGHTING®

LED AYDINLATMA SİSTEMLERİ

MEISSA

30x30 SIVA ALTI CLIP-IN BACKLIGHT LED PANEL



SIVA ALTI

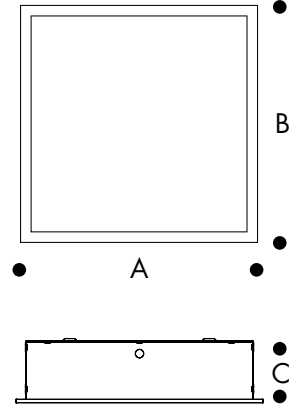

KOD	(V)	(W)	Lümen	Kelvin	IP	Güç Ünitesi	A (mm)	B (mm)	C (mm)	Kesim Ölçüsü (mm)	Kasa Rengi	FİYAT (USD)
102.05.3113	220V	12W	950	3000K	40	VAR	295	295	65	275x275	BEYAZ	\$ 36,00
102.05.3114	220V	12W	950	4000K	40	VAR	295	295	65	275x275	BEYAZ	\$ 36,00
102.05.3116	220V	12W	950	6500K	40	VAR	295	295	65	275x275	BEYAZ	\$ 36,00

- DKP Sac gövde
- Alüminyum çerçeve
- Opal PC/PMMA difüzör
- IP40 koruma sınıfı

Luminous Intensity Distribution Curve

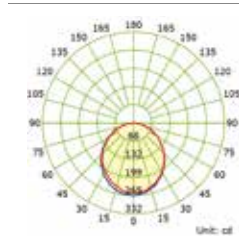

Illuminance at a Distance

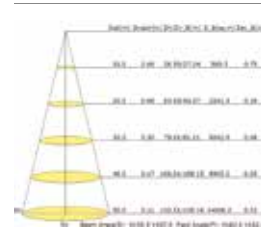

Vertical IsoLux Plot

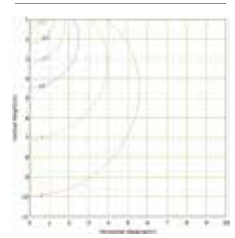

ANCHALIGHTING®

LED AYDINLATMA SİSTEMLERİ

MEISSA

60x60 SIVA ÜSTÜ LED PANEL



SIVA ÜSTÜ

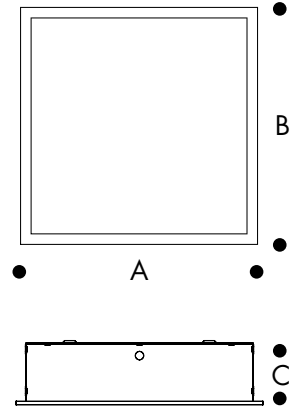
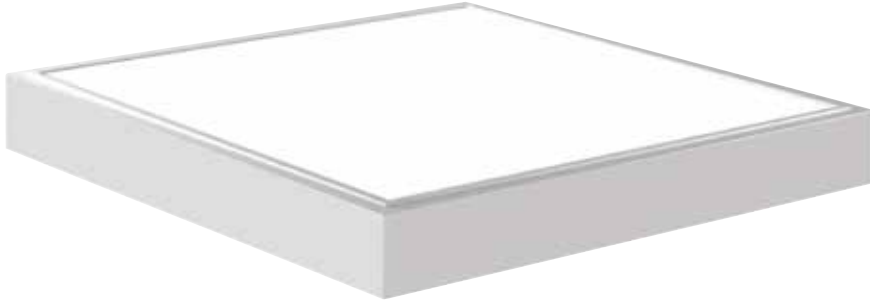

KOD	(V)	(W)	Lümen	Kelvin	IP	Güç Ünitesi	A (mm)	B (mm)	C (mm)	Kasa Rengi	FİYAT (USD)
102.09.3113	220V	40W	3450	3000K	40	VAR	600	600	65	BEYAZ	\$ 100,00
102.09.3114	220V	40W	3450	4000K	40	VAR	600	600	65	BEYAZ	\$ 100,00
102.09.3116	220V	40W	3450	6500K	40	VAR	600	600	65	BEYAZ	\$ 100,00

- DKP Sac gövde
- Alüminyum çerçeve
- Opal PC/PMMA difüzör
- IP40 koruma sınıfı

Luminous Intensity Distribution Curve

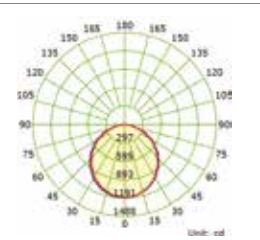

Illuminance at a Distance

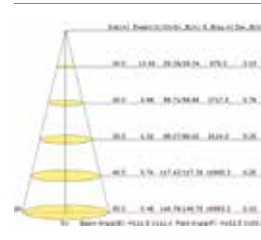

Vertical IsoLux Plot

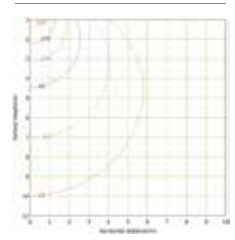

ANCHALIGHTING®

LED AYDINLATMA SİSTEMLERİ

MEISSA

60x60 SIVA ALTI BACKLIGHT LED PANEL



SIVA ALTI

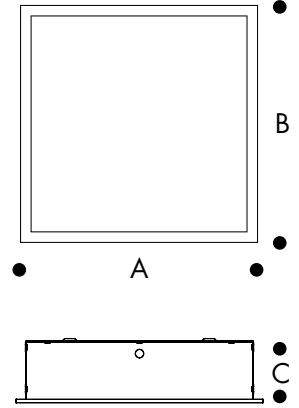

KOD	(V)	(W)	Lümen	Kelvin	IP	Güç Ünitesi	A (mm)	B (mm)	C (mm)	Kasa Rengi	FİYAT (USD)
102.01.3113	220V	40W	3950	3000K	40	VAR	595	595	65	BEYAZ	\$ 65,00
102.01.3114	220V	40W	3950	4000K	40	VAR	595	595	65	BEYAZ	\$ 65,00
102.01.3116	220V	40W	3950	6500K	40	VAR	595	595	65	BEYAZ	\$ 65,00

- DKP Sac gövde
- Alüminyum çerçeve
- Opal PC/PMMA difüzör
- IP40 koruma sınıfı

Luminous Intensity Distribution Curve

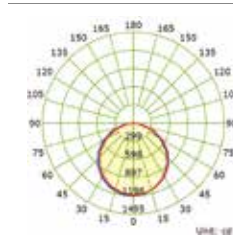

Illuminance at a Distance

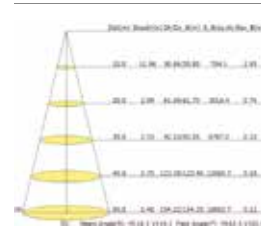

Vertical IsoLux Plot

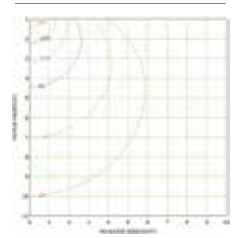

ANCHALIGHTING®

LED AYDINLATMA SİSTEMLERİ

MEISSA

60x60 SIVA ALTI CLIP-IN BACKLIGHT LED PANEL

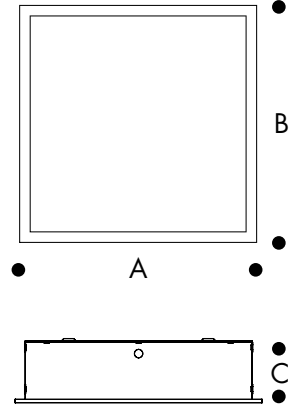

KOD	(V)	(W)	Lümen	Kelvin	IP	Güç Ünitesi	A (mm)	B (mm)	C (mm)	Kasa Rengi	FİYAT (USD)
102.04.3113	220V	40W	3950	3000K	40	VAR	595	595	65	BEYAZ	\$ 65,00
102.04.3114	220V	40W	3950	4000K	40	VAR	595	595	65	BEYAZ	\$ 65,00
102.04.3116	220V	40W	3950	6500K	40	VAR	595	595	65	BEYAZ	\$ 65,00

- DKP Sac gövde
- Alüminyum çerçeve
- Opal PC/PMMA difüzör
- IP40 koruma sınıfı

Luminous Intensity Distribution Curve

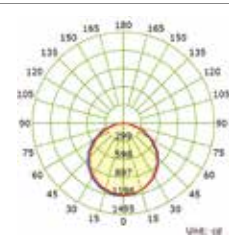

Illuminance at a Distance

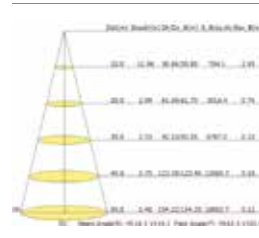

Vertical IsoLux Plot

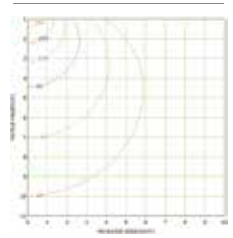

ANCHALIGHTING®
LED AYDINLATMA SİSTEMLERİ

ASTERION



LED AYDINLATMA SİSTEMLERİ

ANCHALIGHTING®

LED AYDINLATMA SİSTEMLERİ

ASTERION

30x30 SLIM LED PANEL



SIVA ALTI

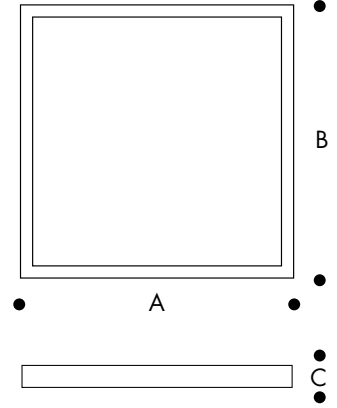

KOD	(V)	(W)	Lümen	Kelvin	IP	Güç Ünitesi	A (mm)	B (mm)	C (mm)	Kasa Rengi	FİYAT (USD)
103.02.3113	220V	20W	1900	3000K	40	VAR	300	300	65	BEYAZ	\$ 26,00
103.02.3114	220V	20W	1900	4000K	40	VAR	300	300	65	BEYAZ	\$ 26,00
103.02.3116	220V	20W	1900	6500K	40	VAR	300	300	65	BEYAZ	\$ 26,00

- Alüminyum çerçeve
- PMMA LGP
- Opal PC/PMMA difüzör
- IP40 koruma sınıfı
- NA-DE LED Driver

Luminous Intensity Distribution Curve

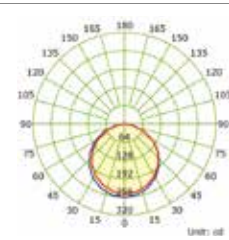

Illuminance at a Distance

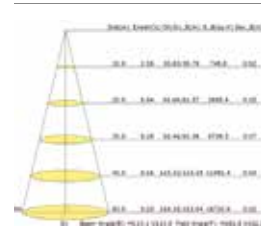

Vertical IsoLux Plot

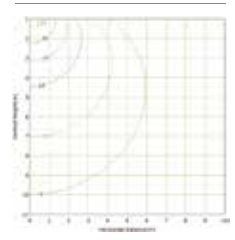

ANCHALIGHTING®

LED AYDINLATMA SİSTEMLERİ

ASTERION

30x60 SLIM LED PANEL



SIVA ALTI

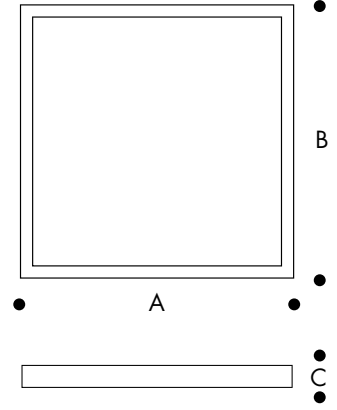

KOD	(V)	(W)	Lümen	Kelvin	IP	Güç Ünitesi	A (mm)	B (mm)	C (mm)	Kasa Rengi	FİYAT (USD)
103.03.3113	220V	36W	2700	3000K	40	VAR	300	600	65	BEYAZ	\$ 52,00
103.03.3114	220V	36W	2700	4000K	40	VAR	300	600	65	BEYAZ	\$ 52,00
103.03.3116	220V	36W	2700	6500K	40	VAR	300	600	65	BEYAZ	\$ 52,00

- Alüminyum çerçeve
- PMMA LGP
- Opal PC/PMMA difüzör
- IP40 koruma sınıfı
- NA-DE LED Driver

Luminous Intensity Distribution Curve

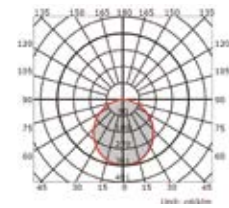

Illuminance at a Distance

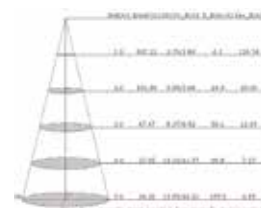

Vertical IsoLux Plot

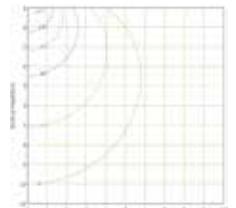

ANCHALIGHTING®

LED AYDINLATMA SİSTEMLERİ

ASTERION

30x120 SLIM LED PANEL



SIVA ALTI

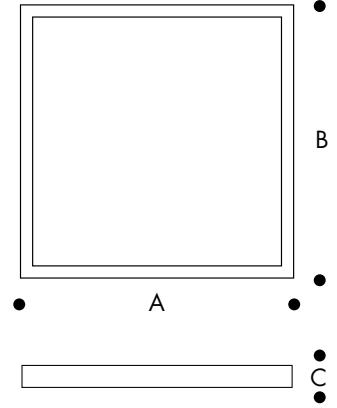

KOD	(V)	(W)	Lümen	Kelvin	IP	Güç Ünitesi	A (mm)	B (mm)	C (mm)	Kasa Rengi	FİYAT (USD)
103.04.3113	220V	40W	3100	3000K	40	VAR	300	1200	65	BEYAZ	\$ 88,00
103.04.3114	220V	40W	3100	4000K	40	VAR	300	1200	65	BEYAZ	\$ 88,00
103.04.3116	220V	40W	3100	6500K	40	VAR	300	1200	65	BEYAZ	\$ 88,00

- Alüminyum çerçeve
- PMMA LGP
- Opal PC/PMMA difüzör
- IP40 koruma sınıfı
- NA-DE LED Driver

Luminous Intensity Distribution Curve

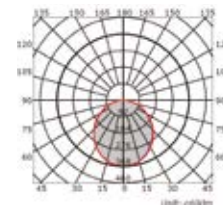

Illuminance at a Distance

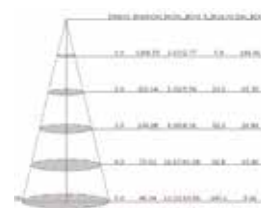

Vertical IsoLux Plot

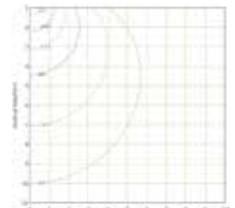

ANCHALIGHTING®

LED AYDINLATMA SİSTEMLERİ

ASTERION

60x60 SLIM LED PANEL



SIVA ALTI

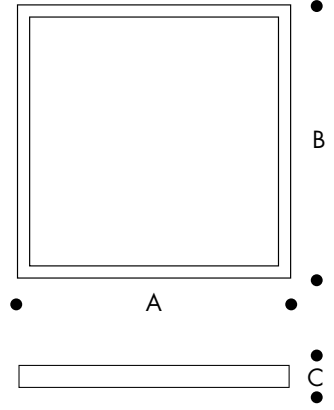

KOD	(V)	(W)	Lümen	Kelvin	IP	Güç Ünitesi	A (mm)	B (mm)	C (mm)	Kasa Rengi	FİYAT (USD)
103.01.3113	220V	40W	3100	3000K	40	VAR	600	600	65	BEYAZ	\$ 41,00
103.01.3114	220V	40W	3100	4000K	40	VAR	600	600	65	BEYAZ	\$ 41,00
103.01.3116	220V	40W	3100	6500K	40	VAR	600	600	65	BEYAZ	\$ 41,00

- Alüminyum çerçeve
- PMMA LGP
- Opal PC/PMMA difüzör
- IP40 koruma sınıfı
- NA-DE LED Driver

Luminous Intensity Distribution Curve

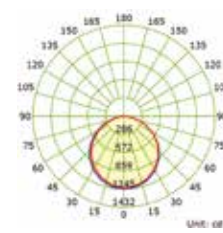

Illuminance at a Distance

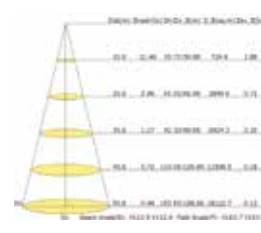

Vertical IsoLux Plot

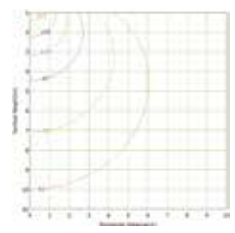

ANCHALIGHTING®

LED AYDINLATMA SİSTEMLERİ

ASTERION

60x60 SLIM LED PANEL SIVA ÜSTÜ ÇEVİRİCİ

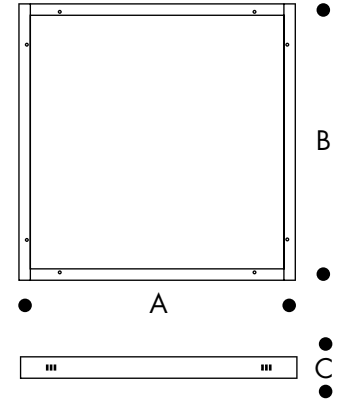

KOD

104.01.3100

FİYAT (USD)

\$ 13,00

- Alüminyum çerçeve
- PMMA LGP
- Opal PC/PMMA difüzör
- IP40 koruma sınıfı
- NA-DE LED Driver

PC/PMMA
OPAL
DİFÜZÖR

DKP SAC
GÖVDE

SIVA ÜSTÜ
MONTAJ



ANCHALIGHTING®
LED AYDINLATMA SİSTEMLERİ

LINA



LED AYDINLATMA SİSTEMLERİ

ANCHALIGHTING®

LED AYDINLATMA SİSTEMLERİ

LINA

POWER SIVA ÜSTÜ LİNEER SERİSİ

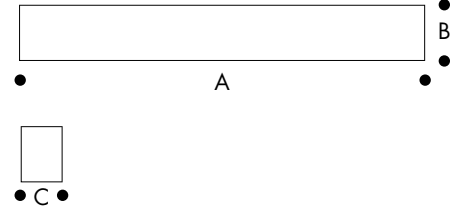
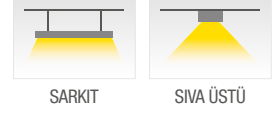

KOD	(V)	(W)	Lümen	Kelvin	IP	Güç Ünitesi	A (mm)	B (mm)	C (mm)	Kasa Rengi	FİYAT (USD)
104.01.2113	220V	40W	2500	3000K	40	VAR	1000	70	48	BEYAZ	\$ 100,00
104.01.2114	220V	40W	2500	4000K	40	VAR	1000	70	48	BEYAZ	\$ 100,00
104.01.2116	220V	40W	2500	6500K	40	VAR	1000	70	48	BEYAZ	\$ 100,00
104.01.2213	220V	40W	2500	4000K	40	VAR	1000	70	48	SİYAH	\$ 100,00
104.01.2214	220V	40W	2500	6500K	40	VAR	1000	70	48	SİYAH	\$ 100,00
104.01.2216	220V	40W	2500	6500K	40	VAR	1000	70	48	SİYAH	\$ 100,00
104.01.2313	220V	40W	2500	4000K	40	VAR	1000	70	48	GRİ	\$ 100,00
104.01.2314	220V	40W	2500	6500K	40	VAR	1000	70	48	GRİ	\$ 100,00
104.01.2316	220V	40W	2500	6500K	40	VAR	1000	70	48	GRİ	\$ 100,00

- Alüminyum gövde
- Opal PC/PMMA difüzör
- IP40 koruma sınıfı

Luminous Intensity Distribution Curve

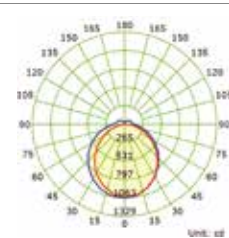

Illuminance at a Distance

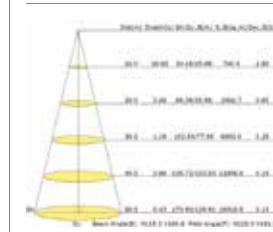

Vertical IsoLux Plot

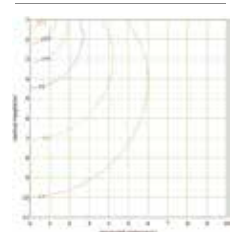

ANCHALIGHTING®

LED AYDINLATMA SİSTEMLERİ

LINA

PURE SIVA ÜSTÜ SLIM LINEER SERİSİ

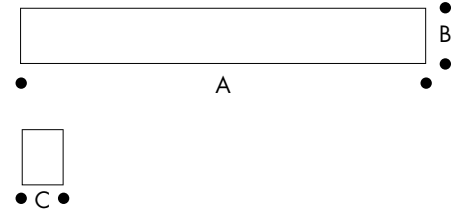
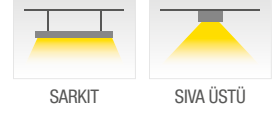

KOD	(V)	(W)	Lümen	Kelvin	IP	Güç Ünitesi	A (mm)	B (mm)	C (mm)	Kasa Rengi	FİYAT (USD)
104.04.2111	220V	45W	-	RGB	40	YOK	1000	60	46	BEYAZ	\$ 100,00
104.04.2112	220V	45W	3400	DYN	40	YOK	1000	60	46	BEYAZ	\$ 100,00
104.04.2211	220V	45W	-	RGB	40	YOK	1000	60	46	SİYAH	\$ 100,00
104.04.2212	220V	45W	3400	DYN	40	YOK	1000	60	46	SİYAH	\$ 100,00
104.04.2311	220V	45W	-	RGB	40	YOK	1000	60	46	GRİ	\$ 100,00
104.04.2312	220V	45W	3400	DYN	40	YOK	1000	60	46	GRİ	\$ 100,00

- RGB: KIRMIZI, YEŞİL, MAVİ
- DYN: DYNAMIC WHITE (3000 ~ 6500K)

Luminous Intensity Distribution Curve

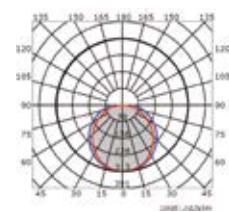

Illuminance at a Distance

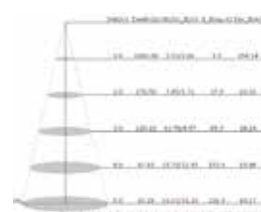

Vertical IsoLux Plot

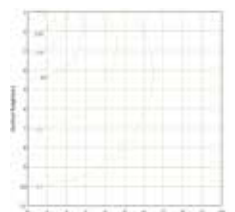

ANCHALIGHTING®

LED AYDINLATMA SİSTEMLERİ

LINA

PURE SIVA ALTI SLIM LINEER SERİSİ



SIVA ALTI

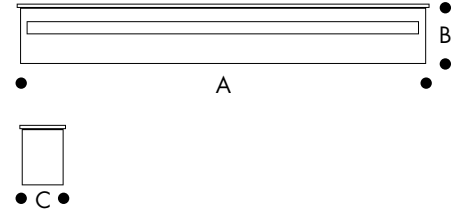

KOD	(V)	(W)	Lümen	Kelvin	IP	Güç Ünitesi	A (mm)	B (mm)	C (mm)	Kesim Ölçüsü (mm)	Kasa Rengi	FİYAT (USD)
104.11.2113	220V	22W	1000	3000K	40	YOK	1000	26	45	1005x28x39	BEYAZ	\$ 100,00
104.11.2114	220V	22W	1000	4000K	40	YOK	1000	26	45	1005x28x39	BEYAZ	\$ 100,00
104.11.2116	220V	22W	1000	6500K	40	YOK	1000	26	45	1005x28x39	BEYAZ	\$ 100,00
104.11.2213	220V	22W	1000	3000K	40	YOK	1000	26	45	1005x28x39	SİYAH	\$ 100,00
104.11.2214	220V	22W	1000	4000K	40	YOK	1000	26	45	1005x28x39	SİYAH	\$ 100,00
104.11.2216	220V	22W	1000	6500K	40	YOK	1000	26	45	1005x28x39	SİYAH	\$ 100,00
104.11.2313	220V	22W	1000	3000K	40	YOK	1000	26	45	1005x28x39	GİRİ	\$ 100,00
104.11.2314	220V	22W	1000	4000K	40	YOK	1000	26	45	1005x28x39	GİRİ	\$ 100,00
104.11.2316	220V	22W	1000	6500K	40	YOK	1000	26	45	1005x28x39	GİRİ	\$ 100,00

Luminous Intensity Distribution Curve

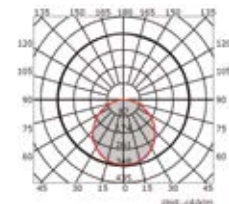

Illuminance at a Distance

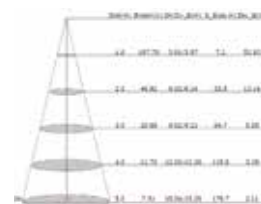

Vertical IsoLux Plot

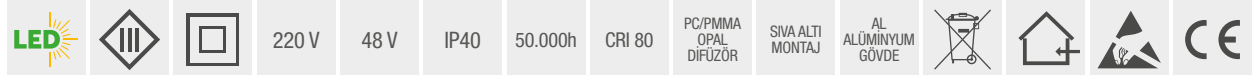
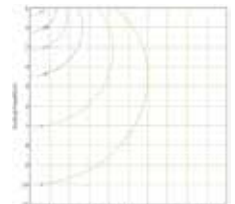

ANCHALIGHTING®

LED AYDINLATMA SİSTEMLERİ

LINATRUNK

KESİNTİSİZ LINEER AYDINLATMA SİSTEMİ

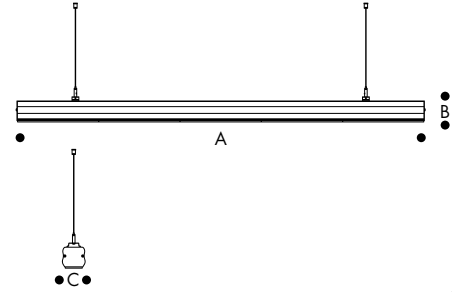
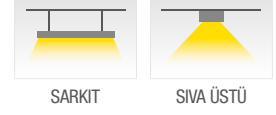

KOD	(V)	(W)	Lümen	Kelvin	IP	Güç Ünitesi	A (mm)	B (mm)	C (mm)	Kasa Rengi	FİYAT (USD)
107.01.2323	220V	37W	5780	3000K	40	VAR	1500	74	80	GRİ	\$ 150,00
107.01.2324	220V	37W	5780	4000K	40	VAR	1500	74	80	GRİ	\$ 150,00
107.01.2326	220V	37W	5780	6500K	40	VAR	1500	74	80	GRİ	\$ 150,00

Luminous Intensity Distribution Curve

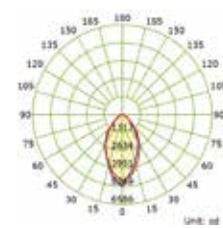

Illuminance at a Distance

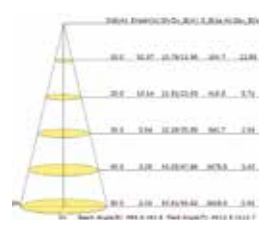

Vertical IsoLux Plot

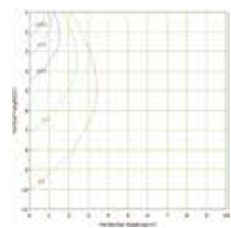

ANCHALIGHTING®

LED AYDINLATMA SİSTEMLERİ

SITULA ETANJ ARMATÜR

ENDÜSTRİYEL ARMATÜRLER



SIVA ÜSTÜ

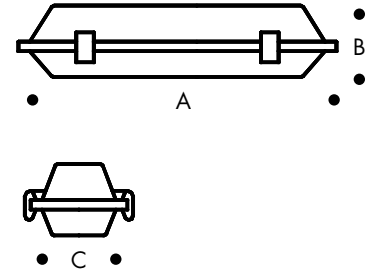

KOD	(V)	(W)	Lümen	Kelvin	IP	Güç Ünitesi	A (mm)	B (mm)	C (mm)	Kasa Rengi	FİYAT (USD)
109.01.3413	220V	40W	3800	3000K	65	VAR	1274	90	90	GRİ	\$ 45,00
109.01.3414	220V	40W	3800	4000K	65	VAR	1274	90	90	GRİ	\$ 45,00
109.01.3416	220V	40W	3800	6500K	65	VAR	1274	90	90	GRİ	\$ 45,00

Luminous Intensity Distribution Curve

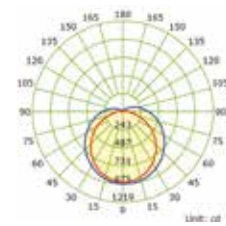

Illuminance at a Distance

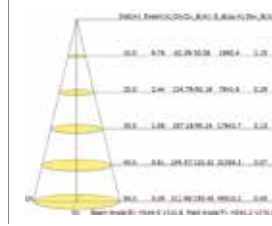

Vertical IsoLux Plot

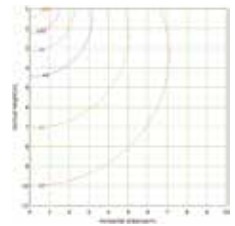

ANCHALIGHTING®

LED AYDINLATMA SİSTEMLERİ

SITULA ACİL AYDINLATMALI ETANJ ARMATÜR

ENDÜSTRİYEL ARMATÜRLER



SIVA ÜSTÜ

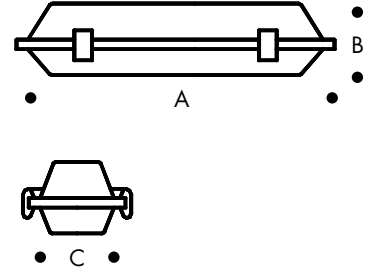

KOD	(V)	(W)	Lümen	Acil Süre	Kelvin	IP	Güç Ünitesi	A (mm)	B (mm)	C (mm)	Kasa Rengi	FİYAT (USD)
109.01.3413-1H	220V	40W	3800	1 Saat	3000K	65	VAR	1274	90	90	GRİ	\$ 102,00
109.01.3414-1H	220V	40W	3800	1 Saat	4000K	65	VAR	1274	90	90	GRİ	\$ 102,00
109.01.3416-1H	220V	40W	3800	1 Saat	6500K	65	VAR	1274	90	90	GRİ	\$ 102,00
109.01.3413-3H	220V	40W	3800	3 Saat	3000K	65	VAR	1274	90	90	GRİ	\$ 150,00
109.01.3414-3H	220V	40W	3800	3 Saat	4000K	65	VAR	1274	90	90	GRİ	\$ 150,00
109.01.3416-3H	220V	40W	3800	3 Saat	6500K	65	VAR	1274	90	90	GRİ	\$ 150,00

Luminous Intensity Distribution Curve

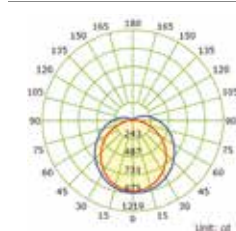

Illuminance at a Distance

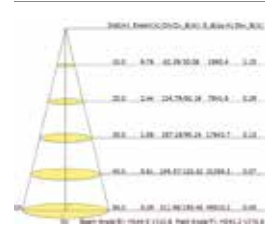

Vertical IsoLux Plot

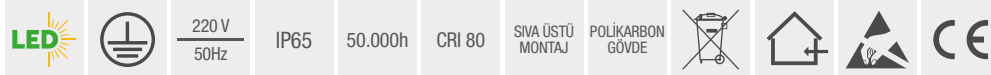
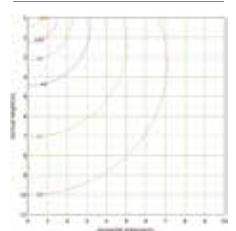

ANCHALIGHTING®

LED AYDINLATMA SİSTEMLERİ

SITULA HF RADAR SENSÖRLÜ ETANJ ARMATÜR

ENDÜSTRİYEL ARMATÜRLER



SIVA ÜSTÜ

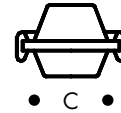
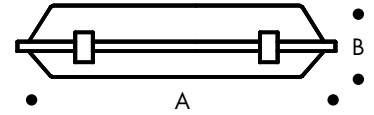

KOD	(V)	(W)	Lümen	Kelvin	IP	Güç Ünitesi	A (mm)	B (mm)	C (mm)	Kasa Rengi	FİYAT (USD)
109.01.3413-R	220V	40W	3800	3000K	65	VAR	1274	90	90	GRİ	\$ 65,00
109.01.3414-R	220V	40W	3800	4000K	65	VAR	1274	90	90	GRİ	\$ 65,00
109.01.3416-R	220V	40W	3800	6500K	65	VAR	1274	90	90	GRİ	\$ 65,00

Luminous Intensity Distribution Curve

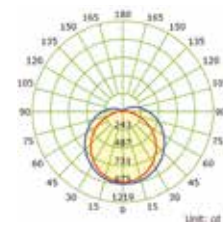

Illuminance at a Distance

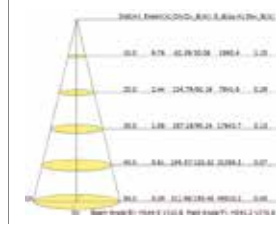

Vertical IsoLux Plot

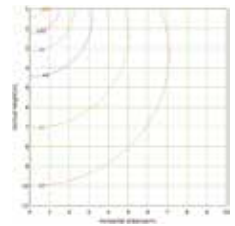

Algılama Etki Alanı	Algılama Yüksekliği	Zaman Ayarı	Gün Işığın Ayarı	Çalışma Sıcaklığı	Koli Bilgisi
360° 7 m - 6 m ↔	2.8 m / 3.5 m	10 sn - 30 dk	2-2000 lux	-20°C ~ +40°C	18 kg 9 Adet 190,00x20,00x30,00

LED	220 V 50Hz	IP65	50.000h	CRI 80	SIVA ÜSTÜ MONTAJ	POLİKARBON GÖVDE	CE
-----	---------------	------	---------	--------	------------------	------------------	----



ANCHALIGHTING®

LED AYDINLATMA SİSTEMLERİ

SITULA HF RADAR SENSÖRLÜ VE ACİL AYDINLATMALI ETANJ ARMATÜRÜ

ENDÜSTRİYEL ARMATÜRLER

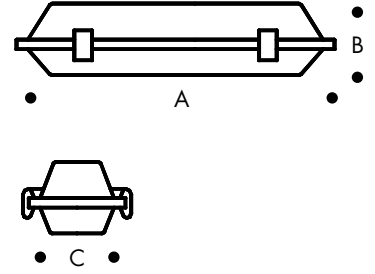

KOD	(V)	(W)	Lümen	Acil Süre	Kelvin	IP	Güç Ünitesi	A (mm)	B (mm)	C (mm)	Kasa Rengi	FİYAT (USD)
109.01.3413-1H-R	220V	40W	3800	1 Saat	3000K	65	VAR	1274	90	90	GRİ	\$ 155,00
109.01.3414-1H-R	220V	40W	3800	1 Saat	4000K	65	VAR	1274	90	90	GRİ	\$ 155,00
109.01.3416-1H-R	220V	40W	3800	1 Saat	6500K	65	VAR	1274	90	90	GRİ	\$ 155,00
109.01.3413-3H-R	220V	40W	3800	3 Saat	3000K	65	VAR	1274	90	90	GRİ	\$ 175,00
109.01.3414-3H-R	220V	40W	3800	3 Saat	4000K	65	VAR	1274	90	90	GRİ	\$ 175,00
109.01.3416-3H-R	220V	40W	3800	3 Saat	6500K	65	VAR	1274	90	90	GRİ	\$ 175,00

Luminous Intensity Distribution Curve

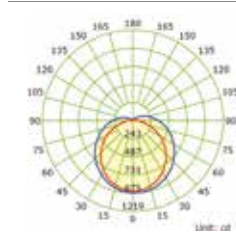

Illuminance at a Distance

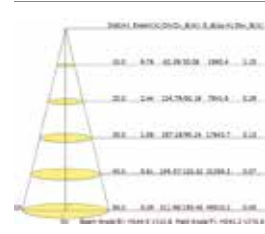

Vertical IsoLux Plot

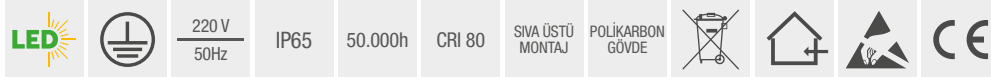
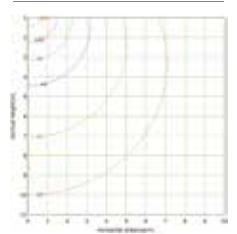

ANCHALIGHTING®

LED AYDINLATMA SİSTEMLERİ

GRASIAS 30

MİMARİ VE PEYZAJ AYDINLATMA ARMATÜRLERİ



SIVA ÜSTÜ

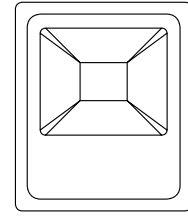

B

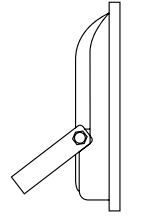

A

C

KOD	(V)	(W)	Lümen	Kelvin	IP	Güç Ünitesi	A (mm)	B (mm)	C (mm)	Kasa Rengi	FİYAT (USD)
113.02.1223	220V	30W	2700	3000K	65	VAR	194	230	49	SİYAH	\$ 31,00
113.02.1224	220V	30W	2700	4000K	65	VAR	194	230	49	SİYAH	\$ 31,00
113.02.1226	220V	30W	2700	6500K	65	VAR	194	230	49	SİYAH	\$ 31,00

Luminous Intensity Distribution Curve

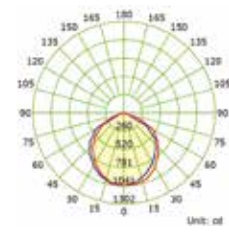

Illuminance at a Distance

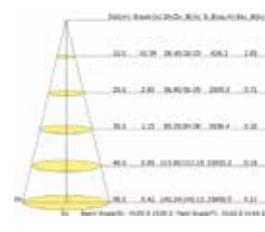

Vertical IsoLux Plot

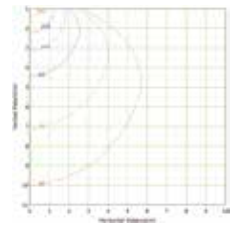

ANCHALIGHTING®

LED AYDINLATMA SİSTEMLERİ

GRASIAS 100

MİMARİ VE PEYZAJ AYDINLATMA ARMATÜRLERİ



SIVA ÜSTÜ

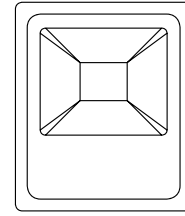

A

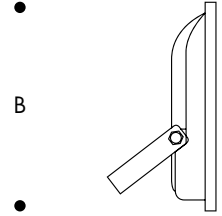

B

C

KOD	(V)	(W)	Lümen	Kelvin	IP	Güç Ünitesi	A (mm)	B (mm)	C (mm)	Kasa Rengi	FİYAT (USD)
113.05.1223	220V	100W	8700	3000K	65	VAR	335	286	76	SİYAH	\$ 95,00
113.05.1224	220V	100W	8700	4000K	65	VAR	335	286	76	SİYAH	\$ 95,00
113.05.1226	220V	100W	8700	6500K	65	VAR	335	286	76	SİYAH	\$ 95,00

Luminous Intensity Distribution Curve

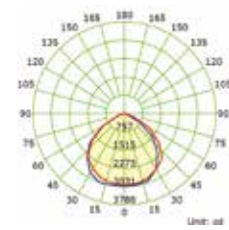

Illuminance at a Distance

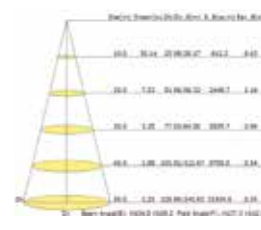

Vertical IsoLux Plot

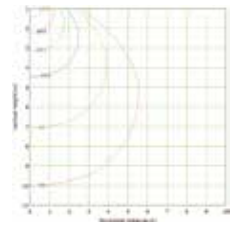

ANCHALIGHTING®

LED AYDINLATMA SİSTEMLERİ

AYDINLATMA ARMATÜRÜ

TA 10220

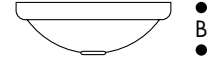
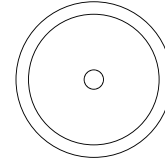

• A •

KOD	(V)	(W)	IP	A (mm)	B (mm)	FİYAT (TL)
114.01.3120	220V	2x60W	20	Ø300	100	35,00

AYDINLATMA ARMATÜRÜ

TA 10220 KROM

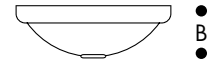
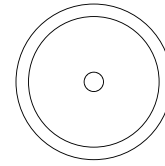

• A •

KOD	(V)	(W)	IP	A (mm)	B (mm)	FİYAT (TL)
114.01.3320	220V	2x60W	20	Ø300	100	65,00



ANCHALIGHTING®

LED AYDINLATMA SİSTEMLERİ

AYDINLATMA ARMATÜRÜ

TA 10330

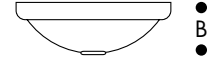
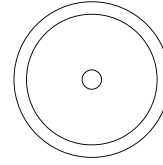

• A •

KOD	(V)	(W)	IP	A (mm)	B (mm)	FİYAT (TL)
114.03.3120	220V	2x60W	20	Ø300	100	50,00

AYDINLATMA ARMATÜRÜ

TA 10330 KROM

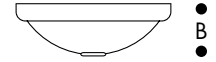
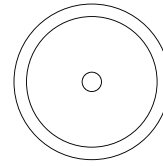

• A •

KOD	(V)	(W)	IP	A (mm)	B (mm)	FİYAT (TL)
114.03.3320	220V	2x60W	20	Ø300	100	80,00



ANCHALIGHTING®

LED AYDINLATMA SİSTEMLERİ

AYDINLATMA ARMATÜRÜ

TA 10430

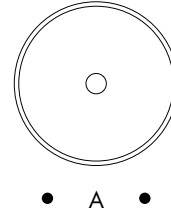

•
B
•

• A •

KOD	(V)	(W)	IP	A (mm)	B (mm)	FİYAT (TL)
114.06.3120	220V	2x60W	20	Ø370	120	70,00

AYDINLATMA ARMATÜRÜ

TA 10430 KROM

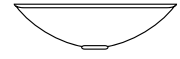
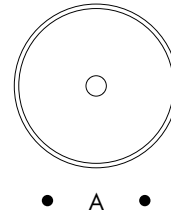

•
B
•

• A •

KOD	(V)	(W)	IP	A (mm)	B (mm)	FİYAT (TL)
114.06.3320	220V	2x60W	20	Ø370	120	100,00



ANCHALIGHTING®

LED AYDINLATMA SİSTEMLERİ

AYDINLATMA ARMATÜRÜ

TA 10400

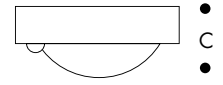
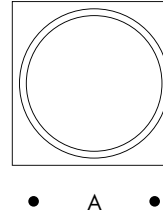

KOD	(V)	(W)	IP	A (mm)	A (mm)	B (mm)	FİYAT (TL)
114.07.4120	220V	1x100W	20	335	335	115	70,00

AYDINLATMA ARMATÜRÜ

TA 10400 GÜMÜŞ GRİ

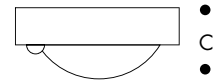
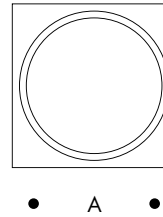

KOD	(V)	(W)	IP	A (mm)	A (mm)	B (mm)	FİYAT (TL)
114.07.4320	220V	1x100W	20	335	335	115	100,00



ANCHALIGHTING®

LED AYDINLATMA SİSTEMLERİ

AYDINLATMA ARMATÜRÜ

10955



SIVA ÜSTÜ

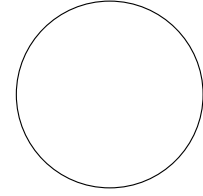

• A •

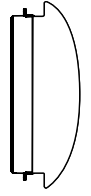

• B •

KOD	(V)	(W)	IP	A (mm)	B (mm)	FİYAT (TL)
114.09.4120	220V	1x60W	20	Ø270	95	100,00



230-240V
50/60Hz

IP20

SIVA ÜSTÜ
MONTAJ



CE



ANCHALIGHTING®

LED AYDINLATMA SİSTEMLERİ

DUVAR TİPİ AYDINLATMA ARMATÜRÜ

10805



SIVA ÜSTÜ

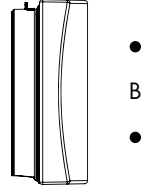
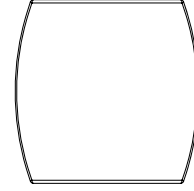

• A •

•
B
•

KOD	(V)	(W)	IP	A (mm)	B (mm)	FİYAT (TL)
114.11.4120	220V	1x60W	43	220	280	115,00





SENSÖR ve SENSÖRLÜ AYDINLATMA SİSTEMLERİ

na·De®

HF SENSÖRLÜ LED ARMATÜR

SENSÖR VE SENSÖRLÜ AYDINLATMA SİSTEMLERİ

15W

10970

300,00 TL



SIVA ÜSTÜ

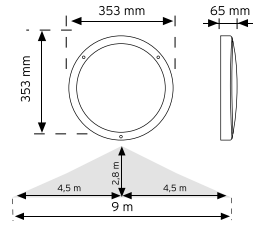

- LED'li aydınlatma sayesinde A sınıfı enerji tüketimi
- HF sensör teknolojisi sayesinde her yönden algılama
- Ayarlanabilir zaman ve lux özelliği
- Camın ve duvarın arkasından algılama
- LED aydınlatma özelliği ile daha fazla enerji tasarrufu

- 2800-3100K
- 4000-4500K
- 6000-6500K
- 1450 Lm

Luminous Intensity Distribution Curve

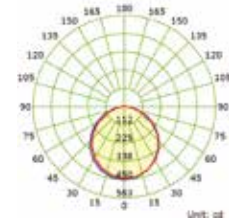

Illuminance at a Distance

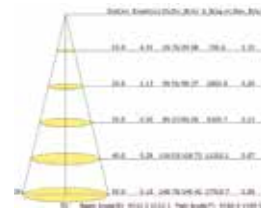

Vertical IsoLux Plot

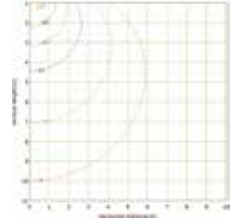

Çalışma Gerilimi 230-240V - 50/60Hz	Aydınlatma Şiddeti 1450 LM	Algılama Etki Alanı 3 m - 9 m ↔	Algılama Yüksekliği 2.8 m	Zaman Ayarı 10 sn ~ 30 dk	Gün Işığı Ayarı 2-2000 lux	Çalışma Sıcaklığı -20°C ~ +40°C	Koruma Derecesi IP 65
--	-------------------------------	------------------------------------	------------------------------	------------------------------	-------------------------------	------------------------------------	--------------------------



HF SENSÖRLÜ LED ARMATÜR

SENSÖR VE SENSÖRLÜ AYDINLATMA SİSTEMLERİ

15W

10971

380,00 TL



SIVA ÜSTÜ

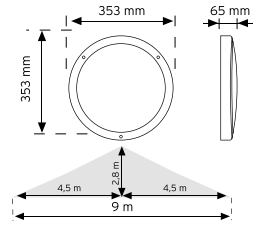

- LED'li aydınlatma sayesinde A sınıfı enerji tüketimi
- HF sensör teknolojisi sayesinde her yönden algılama
- Ayarlanabilir zaman ve lux özelliği
- Camın ve duvarın arkasından algılama
- LED aydınlatma özelliği ile daha fazla enerji tasarrufu

- 2800-3100K
- 4000-4500K
- 6000-6500K
- Normal Yanma 1450 Lm

Luminous Intensity Distribution Curve

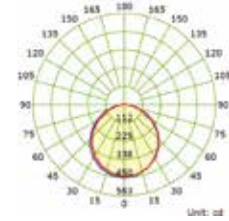

Illuminance at a Distance

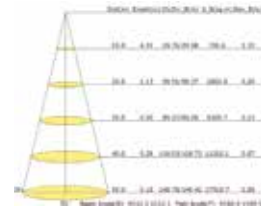

Vertical IsoLux Plot

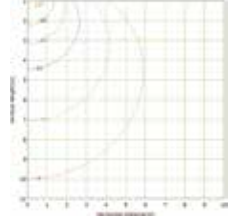

Çalışma Gerilimi 230-240V - 50/60Hz	Aydınlatma Şiddeti 1450 LM	Algılama Etki Alanı 3 m - 9 m ↔	Algılama Yüksekliği 2.8 m	Zaman Ayarı 10 sn ~ 30 dk	Gün Işığı Ayarı 2-2000 lux	Çalışma Sıcaklığı -20°C ~ +40°C	Koruma Derecesi IP 65
--	-------------------------------	------------------------------------	------------------------------	------------------------------	-------------------------------	------------------------------------	--------------------------



LED ARMATÜR

SENSÖR VE SENSÖRLÜ AYDINLATMA SİSTEMLERİ

15W

10972

280,00 TL



SIVA ÜSTÜ

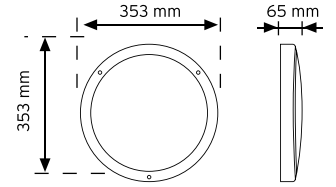

- LED'li aydınlatma sayesinde A sınıfı enerji tüketimi
- LED aydınlatma özelliği ile daha fazla enerji tasarrufu
- 2800-3100K
- 4000-4500K
- 6000-6500K
- 1200 Lm

Luminous Intensity Distribution Curve

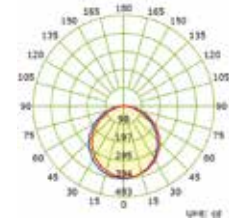



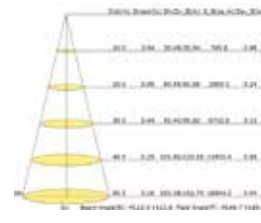

Illuminance at a Distance

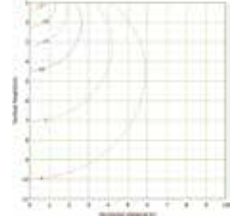

Vertical IsoLux Plot



Çalışma Gerilimi	Aydınlatma Şiddeti	Çalışma Sıcaklığı	Koruma Derecesi
 230-240V- 50/60Hz	 1200 LM	 -20°C ~ +40°C	 II Sınıfı



LED ARMATÜR

SENSÖR VE SENSÖRLÜ AYDINLATMA SİSTEMLERİ

15W

10973

370,00 TL



ACİL AYDINLATMA



SIVA ÜSTÜ

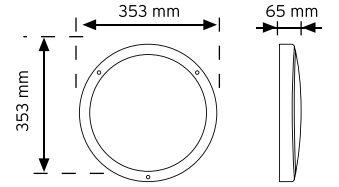

- LED'li aydınlatma sayesinde A sınıfı enerji tüketimi
- LED aydınlatma özelliği ile daha fazla enerji tasarrufu
- Elektrik kesintisinde LED'li aydınlatma
- 3x1000mAh Ni-Mh Pil
- 2 saat acil aydınlatma süresi
- 2800-3100K
- 4000-4500K
- 6000-6500K
- Normal Yanma: 1200 Lm
- Acilde Yanma: 100 Lm

Luminous Intensity Distribution Curve

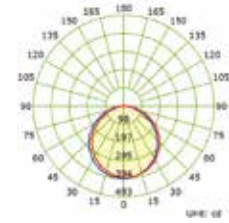

Illuminance at a Distance

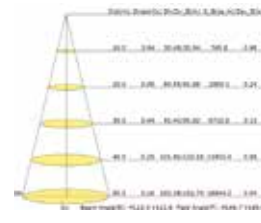

Vertical IsoLux Plot

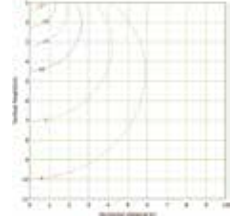

Çalışma Gerilimi	Aydınlatma Şiddeti	Acil Aydınlatma Şiddeti	Çalışma Sıcaklığı	Koruma Derecesi
230-240V - 50/60Hz	1200 LM	100 LM	-20°C ~ +40°C	IP 65



TS EN 60669-2-1
TS EN 60598-2-1
CE

360° HAREKET SENSÖRLÜ LED'Lİ TAVAN ARMATÜRÜ

SENSÖR VE SENSÖRLÜ AYDINLATMA SİSTEMLERİ

12W

01000

150,00 TL



SIVA ÜSTÜ

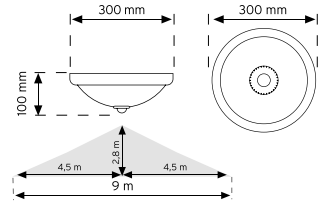

sensor**PLUS**

- LED'li aydınlatma sayesinde A sınıfı enerji tüketimi
- 360° hareket sensörü sayesinde her yönden algılama
- Kumlu cam sayesinde göz yormayan aydınlatma
- Dijital kontrol sayesinde hatasız algılama
- Ayarlanabilir zaman ve lux özelliği
- Siva üstü kolay montaj
- LED aydınlatma özelliği ile daha fazla enerji tasarrufu

- 2800-3100K
- 4000-4500K
- 6000-6500K
- 1050 Lm

Luminous Intensity Distribution Curve

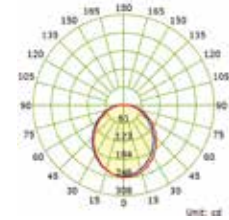

Illuminance at a Distance

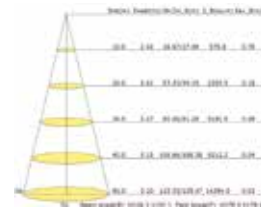

Vertical IsoLux Plot

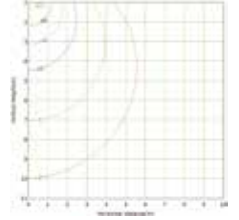

Çalışma Gerilimi 230-240V-50/60Hz	Aydınlatma Şiddeti LM 1050 LM	Algılama Etki Alanı 360° Max. 9 m ↔	Algılama Yüksekliği h 2.8 m	Zaman Ayarı 10 sn ~ 5 dk	Gün Işığı Ayarı 2-2000 lux	Çalışma Sıcaklığı -20°C ~ +40°C	Koruma Derecesi IP 20 I Sınıfı	Koli Bilgisi 17 kg 14 Adet 71,50x62,00x33,00
--------------------------------------	-------------------------------------	---	-----------------------------------	-----------------------------	-------------------------------	------------------------------------	---	---



360° HAREKET SENSÖRLÜ LED'Lİ TAVAN ARMATÜRÜ

SENSÖR VE SENSÖRLÜ AYDINLATMA SİSTEMLERİ

12W

01000 KROM

180,00 TL



SIVA ÜSTÜ

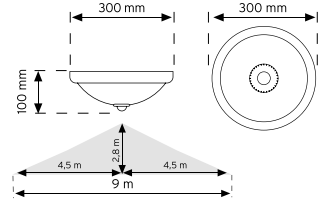

sensor**PLUS**

- LED'li aydınlatma sayesinde A sınıfı enerji tüketimi
- 360° hareket sensörü sayesinde her yönden algılama
- Kumlu cam sayesinde göz yormayan aydınlatma
- Dijital kontrol sayesinde hatasız algılama
- Ayarlanabilir zaman ve lux özelliği
- Sıva üstü kolay montaj
- LED aydınlatma özelliği ile daha fazla enerji tasarrufu

- 2800-3100K
- 4000-4500K
- 6000-6500K
- 1050 Lm

Luminous Intensity Distribution Curve

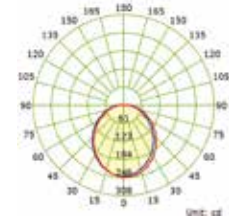

Illuminance at a Distance

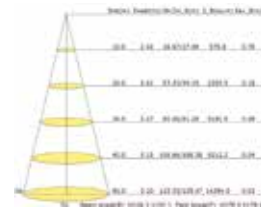

Vertical IsoLux Plot

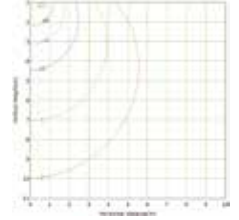

Çalışma Gerilimi 230-240V-50/60Hz	Aydınlatma Şiddeti LM 1050 LM	Algılama Etki Alanı 360° Max. 9 m ↔	Algılama Yüksekliği h 2.8 m	Zaman Ayarı 10 sn ~ 5 dk	Gün Işığı Ayarı 2-2000 lux	Çalışma Sıcaklığı -20°C ~ +40°C	Koruma Derecesi IP 20 I Sınıfı	Koli Bilgisi 17 kg 14 Adet 71,50x62,00x33,00
--------------------------------------	-------------------------------------	---	-----------------------------------	-----------------------------	-------------------------------	------------------------------------	---	---



TS EN 60669-2-1
TS EN 60598-2-1
CE



360° HAREKET SENSÖRLÜ LED'Lİ TAVAN ARMATÜRÜ

SENSÖR VE SENSÖRLÜ AYDINLATMA SİSTEMLERİ

12W

01051

225,00 TL



SIVA ÜSTÜ

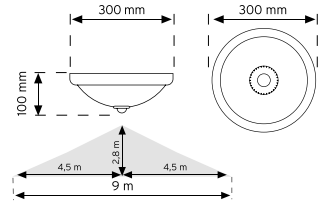

sensorPLUS®

- LED'li aydınlatma sayesinde A sınıfı enerji tüketimi
- 360° hareket sensörü sayesinde her yönden algılama
- Kumlu cam sayesinde göz yormayan aydınlatma
- Dijital kontrol sayesinde hatasız algılama
- Ayarlanabilir zaman ve lux özelliği
- Sıva üstü kolay montaj
- LED aydınlatma özelliği ile daha fazla enerji tasarrufu
- Elektrik kesintisinde LED'li aydınlatma
- 3x1000mAh Ni-Mh Pil
- 2 saat acil aydınlatma süresi

- 2800-3100K
- 4000-4500K
- 6000-6500K
- 1050 Lm

Luminous Intensity Distribution Curve

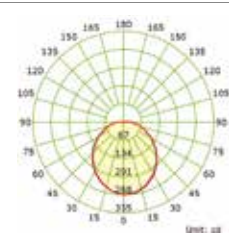

Illuminance at a Distance

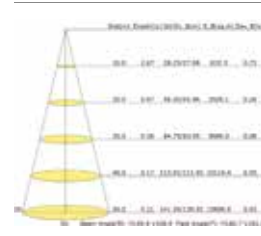

Vertical IsoLux Plot

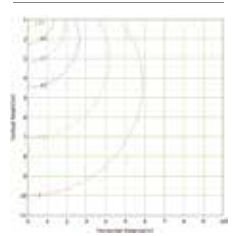

Çalışma Gerilimi	Aydınlatma Şiddeti	Acil Aydınlatma Şiddeti	Algılama Etki Alanı	Algılama Yüksekliği	Zaman Ayarı	Gün Işığı Ayarı	Çalışma Sıcaklığı	Koruma Derecesi	Koli Bilgisi
230-240V - 50/60Hz	1050 LM	100 LM	360°	2.8 m	10 sn ~ 5 dk	2-2000 lux	-20°C ~ +40°C	IP 20	17 kg 14 Adet 71,50x62,00x33,00



TS EN 60669-2-1
TS EN 60598-2-1
CE



360° HAREKET SENSÖRLÜ LED'Lİ TAVAN ARMATÜRÜ

SENSÖR VE SENSÖRLÜ AYDINLATMA SİSTEMLERİ

12W

01051 KROM

255,00 TL



SIVA ÜSTÜ

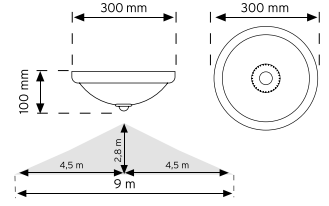

sensorPLUS®

- LED'li aydınlatma sayesinde A sınıfı enerji tüketimi
- 360° hareket sensörü sayesinde her yönden algılama
- Kumlu cam sayesinde göz yormayan aydınlatma
- Dijital kontrol sayesinde hatasız algılama
- Ayarlanabilir zaman ve lux özelliği
- Sıva üstü kolay montaj
- LED aydınlatma özelliği ile daha fazla enerji tasarrufu
- Elektrik kesintisinde LED'li aydınlatma
- 3x1000mAh Ni-Mh Pili
- 2 saat acil aydınlatma süresi

- 2800-3100K
- 4000-4500K
- 6000-6500K
- Normal Yanma: 1050 Lm
- Acilde Yanma: 100 Lm

Luminous Intensity Distribution Curve

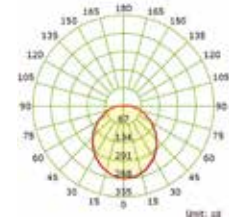

Illuminance at a Distance

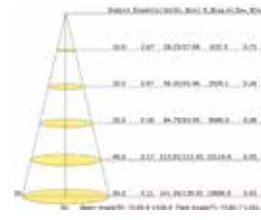

Vertical IsoLux Plot

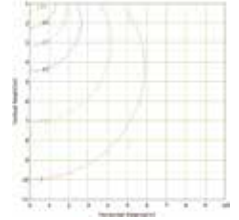

Çalışma Gerilimi 230-240V - 50/60Hz	Aydınlatma Şiddeti LM 1050 LM	Acil Aydınlatma Şiddeti LM 100 LM	Algılama Etki Alanı 360° Max. 9 m	Algılama Yüksekliği h 2.8 m	Zaman Ayarı 10 sn ~ 5 dk	Gün Işığı Ayarı 2-2000 lux	Çalışma Sıcaklığı -20°C ~ +40°C	Koruma Derecesi IP 20 I Sınıfı	Koli Bilgisi 17 kg 14 Adet 71,50x62,00x33,00
--	-------------------------------------	---	---	-----------------------------------	-----------------------------	-------------------------------	------------------------------------	--------------------------------------	---



TS EN 60669-2-1
TS EN 60598-2-1
CE



360° HAREKET SENSÖRLÜ LED'Lİ TAVAN ARMATÜRÜ

SENSÖR VE SENSÖRLÜ AYDINLATMA SİSTEMLERİ

12W

00333

105,00 TL



SIVA ÜSTÜ

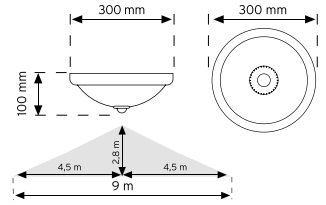

sensor **PLUS**

- LED'li aydınlatma sayesinde A sınıfı enerji tüketimi
- 360° hareket sensörü sayesinde her yönden algılama
- Kumlu cam sayesinde göz yormayan aydınlatma
- Dijital kontrol sayesinde hatasız algılama
- Ayarlanabilir zaman ve lux özelliği
- Sıva üstü kolay montaj
- LED aydınlatma özelliği ile daha fazla enerji tasarrufu

- 2800-3100K
- 4000-4500K
- 6000-6500K
- 1450 Lm

Luminous Intensity Distribution Curve

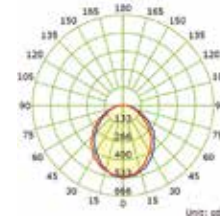

Illuminance at a Distance

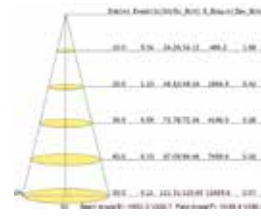

Vertical IsoLux Plot

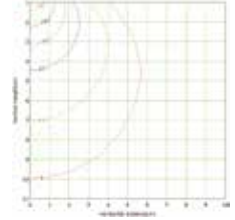

Çalışma Gerilimi 230-240V - 50/60Hz	Aydınlatma Şiddeti LM 1050 LM	Algılama Etki Alanı 360° Max. 9 m ↔	Algılama Yüksekliği h 2.8 m	Zaman Ayarı 10 sn ~ 5 dk	Gün Işığı Ayarı 2-2000 lux	Çalışma Sıcaklığı -20°C ~ +40°C	Koruma Derecesi IP 20 I Sınıfı	Koli Bilgisi 17 kg 14 Adet 71,50x62,00x33,00
--	-------------------------------------	---	-----------------------------------	-----------------------------	-------------------------------	------------------------------------	---	---



360° HAREKET SENSÖRLÜ LED'Lİ ACİL AYDINLATMALI TAVAN ARMATÜRÜ

SENSÖR VE SENSÖRLÜ AYDINLATMA SİSTEMLERİ

12W

00333.01

160,00 TL



SIVA ÜSTÜ



sensor **PLUS**

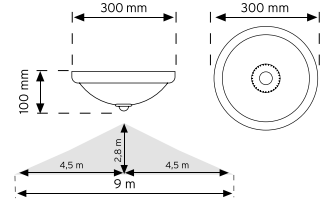

- LED'li aydınlatma sayesinde A sınıfı enerji tüketimi
- 360° hareket sensörü sayesinde her yönden algılama
- Kumlu cam sayesinde göz yormayan aydınlatma
- Dijital kontrol sayesinde hatasız algılama
- Ayarlanabilir zaman ve lux özelliği
- Sıva üstü kolay montaj
- LED aydınlatma özelliği ile daha fazla enerji tasarrufu
- Elektrik kesintisinde LED'li aydınlatma
- 3x1000mAh Ni-Mh Pili
- 2 saat acil aydınlatma süresi

- 2800-3100K
- 4000-4500K
- 6000-6500K
- Normal Yanma 1450 Lm
- Acil'de Yanma 100 Lm

Luminous Intensity Distribution Curve

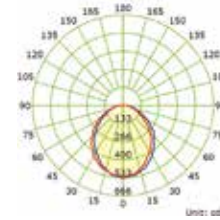

Illuminance at a Distance

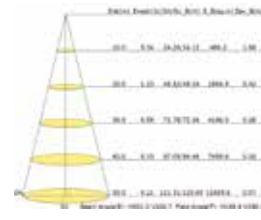

Vertical IsoLux Plot

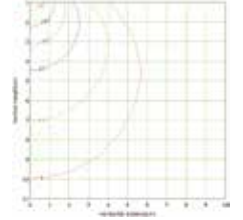

Çalışma Gerilimi 230-240V - 50/60Hz	Aydınlatma Şiddeti LM 1050 LM	Acil Aydınlatma Şiddeti LM 100 LM	Algılama Etki Alanı 360° Max. 9 m	Algılama Yüksekliği h 2.8 m	Zaman Ayarı 10 sn ~ 5 dk	Gün Işığı Ayarı 2-2000 lux	Çalışma Sıcaklığı -20°C ~ +40°C	Koruma Derecesi IP 20 I Sınıfı	Koli Bilgisi 17 kg 14 Adet 71,50x62,00x33,00
--	-------------------------------------	---	---	-----------------------------------	-----------------------------	-------------------------------	------------------------------------	--------------------------------------	---



TS EN 60669-2-1
TS EN 60598-2-1
CE



360° HAREKET SENSÖRLÜ LED'Lİ TAVAN ARMATÜRÜ

SENSÖR VE SENSÖRLÜ AYDINLATMA SİSTEMLERİ

18W

10551

170,00 TL



SIVA ÜSTÜ

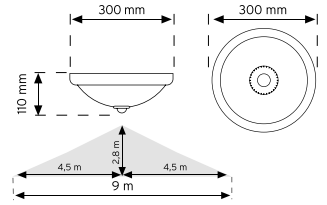

- LED'li aydınlatma sayesinde A sınıfı enerji tüketimi
- 360° hareket sensörü sayesinde her yönden algılama
- Kumlu cam sayesinde göz yormayan aydınlatma
- Dijital kontrol sayesinde hatasız algılama
- Ayarlanabilir zaman ve lux özelliği
- Siva üstü kolay montaj
- LED aydınlatma özelliği ile daha fazla enerji tasarrufu

- 2800-3100K
- 4000-4500K
- 6000-6500K
- 1150 Lm

Luminous Intensity Distribution Curve

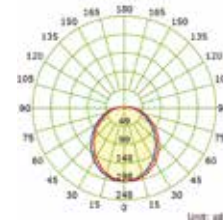

Illuminance at a Distance

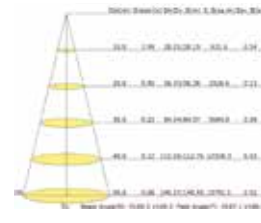

Vertical IsoLux Plot

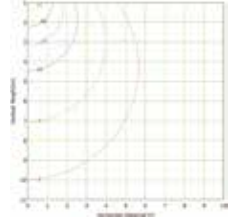

Çalışma Gerilimi 230-240V-50/60Hz	Aydınlatma Şiddeti LM 1150 LM	Algılama Etki Alanı 360° Max. 9 m ↔	Algılama Yüksekliği h 2.8 m	Zaman Ayarı 10 sn ~ 5 dk	Gün Işığı Ayarı 2-2000 lux	Çalışma Sıcaklığı -20°C ~ +40°C	Koruma Derecesi IP 20 I Sınıfı	Koli Bilgisi 17 kg 14 Adet 71,50x62,00x33,00
--------------------------------------	-------------------------------------	---	-----------------------------------	-----------------------------	-------------------------------	------------------------------------	---	---



360° HAREKET SENSÖRLÜ LED'Lİ TAVAN ARMATÜRÜ

SENSÖR VE SENSÖRLÜ AYDINLATMA SİSTEMLERİ

18W

10551 KROM

200,00 TL



SIVA ÜSTÜ

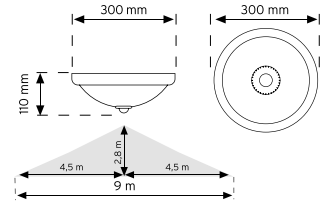

- LED'li aydınlatma sayesinde A sınıfı enerji tüketimi
- 360° hareket sensörü sayesinde her yönden algılama
- Kumlu cam sayesinde göz yormayan aydınlatma
- Dijital kontrol sayesinde hatasız algılama
- Ayarlanabilir zaman ve lux özelliği
- Sıva üstü kolay montaj
- LED aydınlatma özelliği ile daha fazla enerji tasarrufu

- 2800-3100K
- 4000-4500K
- 6000-6500K
- 1150 Lm

Luminous Intensity Distribution Curve

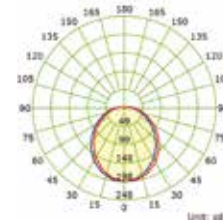

Illuminance at a Distance

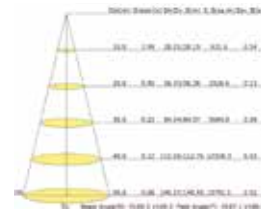

Vertical IsoLux Plot

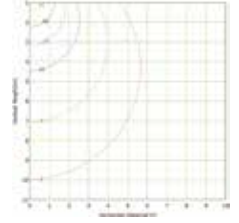

Çalışma Gerilimi 230-240V-50/60Hz	Aydınlatma Şiddeti LM 1150 LM	Algılama Etki Alanı 360° Max. 9 m	Algılama Yüksekliği h 2.8 m	Zaman Ayarı 10 sn ~ 5 dk	Gün Işığı Ayarı 2-2000 lux	Çalışma Sıcaklığı -20°C ~ +40°C	Koruma Derecesi IP 20 I Sınıfı	Koli Bilgisi 17 kg 14 Adet 71.50x62.00x33.00
--------------------------------------	-------------------------------------	---	-----------------------------------	-----------------------------	-------------------------------	------------------------------------	---	---



TS EN 60669-2-1
TS EN 60598-2-1
CE



360° HAREKET SENSÖRLÜ LED'Lİ ACİL AYDINLATMALI TAVAN ARMATÜRÜ

SENSÖR VE SENSÖRLÜ AYDINLATMA SİSTEMLERİ

18W

10651

215,00 TL



SIVA ÜSTÜ

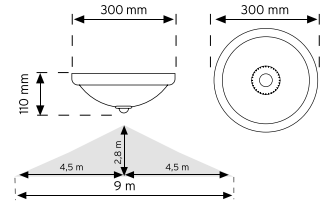

- LED'li aydınlatma sayesinde A sınıfı enerji tüketimi
- 360° hareket sensörü sayesinde her yönden algılama
- Kumlu cam sayesinde göz yormayan aydınlatma
- Dijital kontrol sayesinde hatasız algılama
- Ayarlanabilir zaman ve lux özelliği
- Sıva üstü kolay montaj
- LED aydınlatma özelliği ile daha fazla enerji tasarrufu
- Elektrik kesintisinde LED'li aydınlatma
- 3x1000mAh Ni-Mh Pili
- 2 saat acil aydınlatma süresi

Luminous Intensity Distribution Curve

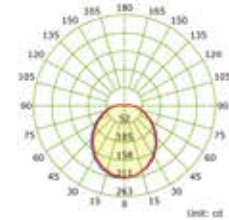

Illuminance at a Distance

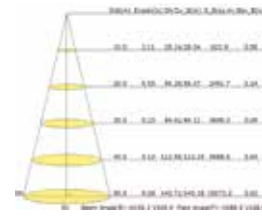

Vertical IsoLux Plot

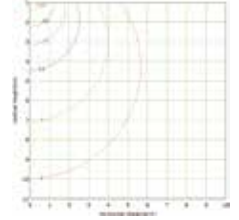

- 2800-3100K
- 4000-4500K
- 6000-6500K
- **Normal Yanma: 1150 Lm**
- **Acilde Yanma: 100 Lm**

Çalışma Gerilimi	Aydınlatma Şiddeti	Acil Aydınlatma Şiddeti	Algılama Etki Alanı	Algılama Yüksekliği	Zaman Ayarı	Gün Işığı Ayarı	Çalışma Sıcaklığı	Koruma Derecesi	Koli Bilgisi
230-240V- 50/60Hz	1150 LM	100 LM	360°	2.8 m	10 sn ~ 5 dk	2-2000 lux	-20°C ~ +40°C	IP 20	18 kg 12 Adet



TS EN 60669-2-1
TS EN 60598-2-1
CE



360° HAREKET SENSÖRLÜ LED'Lİ ACİL AYDINLATMALI TAVAN ARMATÜRÜ

SENSÖR VE SENSÖRLÜ AYDINLATMA SİSTEMLERİ

18W

10651 KROM

245,00 TL



SIVA ÜSTÜ

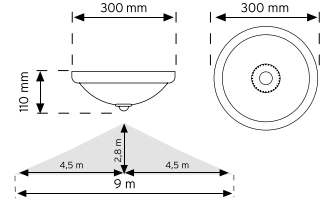

- LED'li aydınlatma sayesinde A sınıfı enerji tüketimi
- 360° hareket sensörü sayesinde her yönden algılama
- Kumlu cam sayesinde göz yormayan aydınlatma
- Dijital kontrol sayesinde hatasız algılama
- Ayarlanabilir zaman ve lux özelliği
- Sıva üstü kolay montaj
- LED aydınlatma özelliği ile daha fazla enerji tasarrufu
- Elektrik kesintisinde LED'li aydınlatma
- 3x1000mAh Ni-Mh Pili
- 2 saat acil aydınlatma süresi

- 2800-3100K
- 4000-4500K
- 6000-6500K
- **Normal Yanma: 1150 Lm**
- **Acilde Yanma: 100 Lm**

Luminous Intensity Distribution Curve

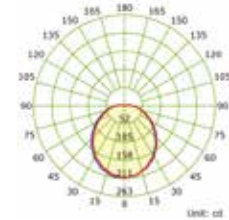

Illuminance at a Distance

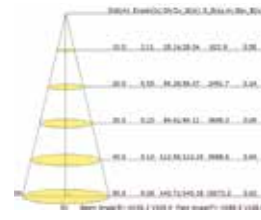

Vertical IsoLux Plot

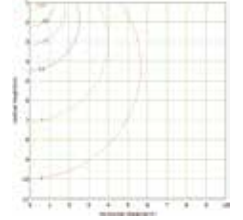

Çalışma Gerilimi 230-240V - 50/60Hz	Aydınlatma Şiddeti LM 1150 LM	Acil Aydınlatma Şiddeti LM 100 LM	Algılama Etki Alanı 360° Max. 9 m ↔	Algılama Yüksekliği h 2.8 m	Zaman Ayarı 10 sn ~ 5 dk	Gün Işığı Ayarı 2-2000 lux	Çalışma Sıcaklığı -20°C ~ +40°C	Koruma Derecesi IP 20 I Sınıfı	Koli Bilgisi 18 kg 12 Adet 71,50x62,00x33,00
--	-------------------------------------	---	---	-----------------------------------	-----------------------------	-------------------------------	------------------------------------	--------------------------------------	---



TS EN 60669-2-1
TS EN 60598-2-1
CE



360° HAREKET SENSÖRLÜ LED'Lİ TAVAN ARMATÜRÜ

SENSÖR VE SENSÖRLÜ AYDINLATMA SİSTEMLERİ

18W

10433

200,00 TL



SIVA ÜSTÜ

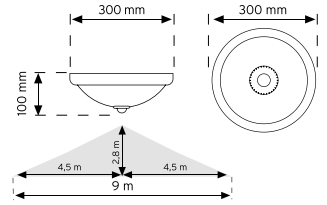

- LED'li aydınlatma sayesinde A sınıfı enerji tüketimi
- 360° hareket sensörü sayesinde her yönden algılama
- Kumlu cam sayesinde göz yormayan aydınlatma
- Dijital kontrol sayesinde hatasız algılama
- Ayarlanabilir zaman ve lux özelliği
- Siva üstü kolay montaj
- LED aydınlatma özelliği ile daha fazla enerji tasarrufu

- 2800-3100K
- 4000-4500K
- 6000-6500K
- 1200 Lm

Luminous Intensity Distribution Curve

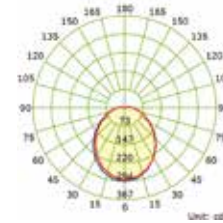

Illuminance at a Distance

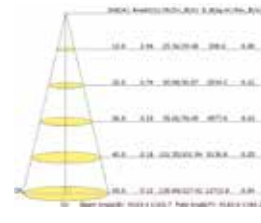

Vertical IsoLux Plot

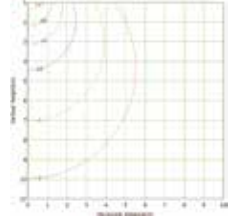

Çalışma Gerilimi 230-240V-50/60Hz	Aydınlatma Şiddeti 1200 LM	Algılama Etki Alanı Max. 9 m ↔	Algılama Yüksekliği 2.8 m	Zaman Ayarı 10 sn ~ 5 dk	Gün Işığın Ayarı 2-2000 lux	Çalışma Sıcaklığı -20°C ~ +40°C	Koruma Derecesi IP 20	Koli Bilgisi 23 kg 8 Adet 82,00x60,00x41,00
--------------------------------------	-------------------------------	-----------------------------------	------------------------------	-----------------------------	--------------------------------	------------------------------------	--------------------------	---



360° HAREKET SENSÖRLÜ LED'Lİ TAVAN ARMATÜRÜ

SENSÖR VE SENSÖRLÜ AYDINLATMA SİSTEMLERİ

18W

10433 KROM

230,00 TL



SIVA ÜSTÜ

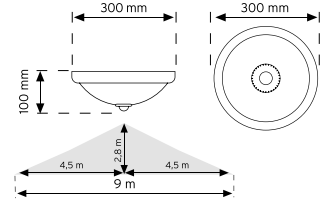

- LED'li aydınlatma sayesinde A sınıfı enerji tüketimi
- 360° hareket sensörü sayesinde her yönden algılama
- Kumlu cam sayesinde göz yormayan aydınlatma
- Dijital kontrol sayesinde hatasız algılama
- Ayarlanabilir zaman ve lux özelliği
- Sıva üstü kolay montaj
- LED aydınlatma özelliği ile daha fazla enerji tasarrufu

- 2800-3100K
- 4000-4500K
- 6000-6500K
- 1200 Lm

Luminous Intensity Distribution Curve

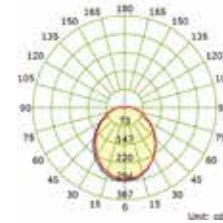

Illuminance at a Distance

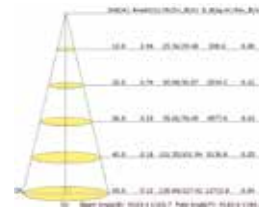

Vertical IsoLux Plot

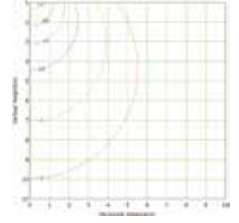

Çalışma Gerilimi 230-240V - 50/60Hz	Aydınlatma Şiddeti LM 1200 LM	Algılama Etki Alanı 360° Max. 9 m ↔	Algılama Yüksekliği h 2.8 m	Zaman Ayarı 10 sn ~ 5 dk	Gün Işığın Ayarı 2-2000 lux	Çalışma Sıcaklığı -20°C ~ +40°C	Koruma Derecesi IP 20	Koli Bilgisi 23 kg 8 Adet 82,00x60,00x41,00
--	-------------------------------------	---	-----------------------------------	-----------------------------	--------------------------------	------------------------------------	-----------------------------	---



TS EN 60669-2-1
TS EN 60598-2-1
CE



360° HAREKET SENSÖRLÜ LED'Lİ ACİL AYDINLATMALI TAVAN ARMATÜRÜ

SENSÖR VE SENSÖRLÜ AYDINLATMA SİSTEMLERİ

18W

10434

270,00 TL



SIVA ÜSTÜ

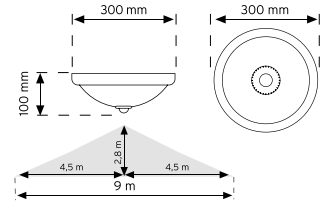

- LED'li aydınlatma sayesinde A sınıfı enerji tüketimi
- 360° hareket sensörü sayesinde her yönden algılama
- Kumlu cam sayesinde göz yormayan aydınlatma
- Dijital kontrol sayesinde hatasız algılama
- Ayarlanabilir zaman ve lux özelliği
- Sıva üstü kolay montaj
- LED aydınlatma özelliği ile daha fazla enerji tasarrufu
- Elektrik kesintisinde LED'li aydınlatma
- 3x1000mAh Ni-Mh Pili
- 2 saat acil aydınlatma süresi

Luminous Intensity Distribution Curve

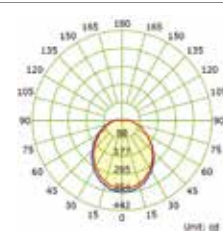

Illuminance at a Distance

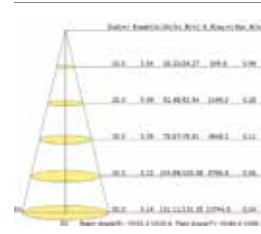

Vertical IsoLux Plot

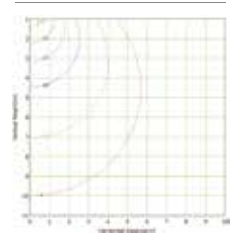

- 2800-3100K
- 4000-4500K
- 6000-6500K
- Normal Yanma: 1200 Lm
- Acilde Yanma: 100 Lm

Çalışma Gerilimi	Aydınlatma Şiddeti	Acil Aydınlatma Şiddeti	Algılama Etki Alanı	Algılama Yüksekliği	Zaman Ayarı	Gün Işığı Ayarı	Çalışma Sıcaklığı	Koruma Derecesi	Koli Bilgisi
230-240V - 50/60Hz	1200 LM	100 LM	360°	2.8 m	10 sn ~ 5 dk	2-2000 lux	-20°C ~ +40°C	IP 20	23 kg 8 Adet



TS EN 60669-2-1
TS EN 60598-2-1
CE



360° HAREKET SENSÖRLÜ LED'Lİ ACİL AYDINLATMALI TAVAN ARMATÜRÜ

SENSÖR VE SENSÖRLÜ AYDINLATMA SİSTEMLERİ

18W

10434 KROM

300,00 TL



ACİL
AYDINLATMA



SIVA ÜSTÜ

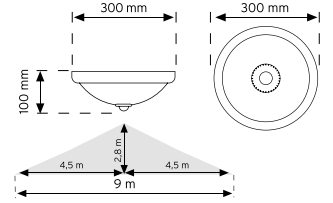

- LED'li aydınlatma sayesinde A sınıfı enerji tüketimi
- 360° hareket sensörü sayesinde her yönden algılama
- Kumlu cam sayesinde göz yormayan aydınlatma
- Dijital kontrol sayesinde hatasız algılama
- Ayarlanabilir zaman ve lux özelliği
- Sıva üstü kolay montaj
- LED aydınlatma özelliği ile daha fazla enerji tasarrufu
- Elektrik kesintisinde LED'li aydınlatma
- 3x1000mAh Ni-Mh Pili
- 2 saat acil aydınlatma süresi

- 2800-3100K
- 4000-4500K
- 6000-6500K
- **Normal Yanma: 1200 Lm**
- **Acilde Yanma: 100 Lm**

Luminous Intensity Distribution Curve

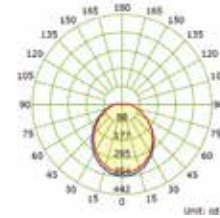

Illuminance at a Distance

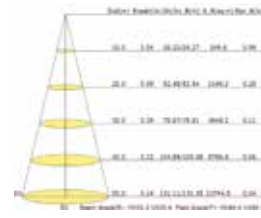

Vertical IsoLux Plot

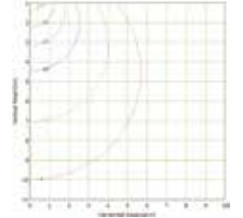

Çalışma Gerilimi 230-240V - 50/60Hz	Aydınlatma Şiddeti LM 1200 LM	Acil Aydınlatma Şiddeti LM 100 LM	Algılama Etki Alanı 360° Max. 9 m ↔	Algılama Yüksekliği h 2.8 m	Zaman Ayarı 10 sn ~ 5 dk	Gün Işığı Ayarı 2-2000 lux	Çalışma Sıcaklığı -20°C ~ +40°C	Koruma Derecesi IP 20 I Sınıfı	Koli Bilgisi 23 kg 8 Adet 82,00x60,00x41,00
--	-------------------------------------	---	---	-----------------------------------	-----------------------------	-------------------------------	------------------------------------	--------------------------------------	--



TS EN 60669-2-1
TS EN 60598-2-1
CE



360° HAREKET SENSÖRLÜ LED'Lİ TAVAN ARMATÜRÜ

SENSÖR VE SENSÖRLÜ AYDINLATMA SİSTEMLERİ

18W

10431

260,00 TL



SIVA ÜSTÜ

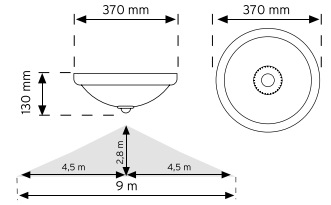

- LED'li aydınlatma sayesinde A sınıfı enerji tüketimi
- 360° hareket sensörü sayesinde her yönden algılama
- Kumlu cam sayesinde göz yormayan aydınlatma
- Dijital kontrol sayesinde hatasız algılama
- Ayarlanabilir zaman ve lux özelliği
- Sıva üstü kolay montaj
- LED aydınlatma özelliği ile daha fazla enerji tasarrufu

- 2800-3100K
- 4000-4500K
- 6000-6500K
- 1200 Lm

Luminous Intensity Distribution Curve

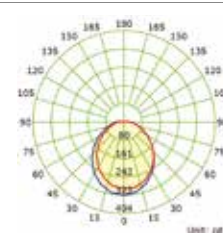

Illuminance at a Distance

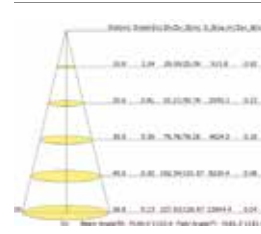

Vertical IsoLux Plot

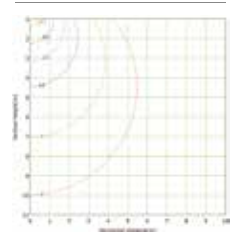

Çalışma Gerilimi 230-240V-50/60Hz	Aydınlatma Şiddeti 1200 LM	Algılama Etki Alanı Max. 9 m	Algılama Yüksekliği 2.8 m	Zaman Ayarı 10 sn ~ 5 dk	Gün Işığ Ayarı 2-2000 lux	Çalışma Sıcaklığı -20°C ~ +40°C	Koruma Derecesi IP 20	Koli Bilgisi 23 kg 8 Adet 82,00x60,00x41,00
--------------------------------------	-------------------------------	---------------------------------	------------------------------	-----------------------------	------------------------------	------------------------------------	--------------------------	---



360° HAREKET SENSÖRLÜ LED'Lİ TAVAN ARMATÜRÜ

SENSÖR VE SENSÖRLÜ AYDINLATMA SİSTEMLERİ

18W

10431 KROM

290,00 TL



SIVA ÜSTÜ

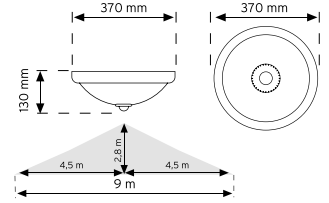

- LED'li aydınlatma sayesinde A sınıfı enerji tüketimi
- 360° hareket sensörü sayesinde her yönden algılama
- Kumlu cam sayesinde göz yormayan aydınlatma
- Dijital kontrol sayesinde hatasız algılama
- Ayarlanabilir zaman ve lux özelliği
- Sıva üstü kolay montaj
- LED aydınlatma özelliği ile daha fazla enerji tasarrufu

- 2800-3100K
- 4000-4500K
- 6000-6500K
- 1200 Lm

Luminous Intensity Distribution Curve

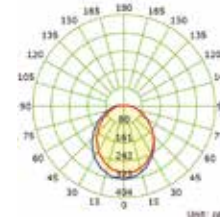

Illuminance at a Distance

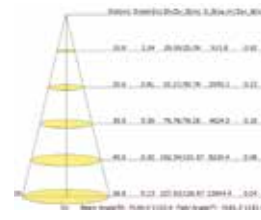

Vertical IsoLux Plot

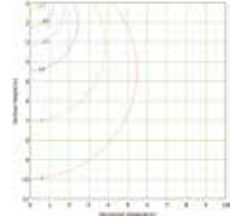

Çalışma Gerilimi 230-240V-50/60Hz	Aydınlatma Şiddeti 1200 LM	Algılama Etki Alanı Max. 9 m ↔	Algılama Yüksekliği 2.8 m	Zaman Ayarı 10 sn ~ 5 dk	Gün Işığın Ayarı 2-2000 lux	Çalışma Sıcaklığı -20°C ~ +40°C	Koruma Derecesi IP 20	Koli Bilgisi 23 kg 8 Adet 82,00x60,00x41,00
--------------------------------------	-------------------------------	-----------------------------------	------------------------------	-----------------------------	--------------------------------	------------------------------------	--------------------------	---



TS EN 60669-2-1
TS EN 60598-2-1
CE



360° HAREKET SENSÖRLÜ LED'Lİ ACİL AYDINLATMALI TAVAN ARMATÜRÜ

SENSÖR VE SENSÖRLÜ AYDINLATMA SİSTEMLERİ

18W

10432

310,00 TL



SIVA ÜSTÜ

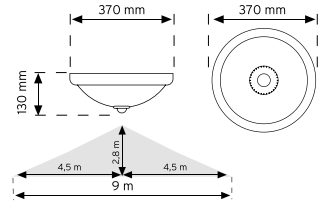

- LED'li aydınlatma sayesinde A sınıfı enerji tüketimi
- 360° hareket sensörü sayesinde her yönden algılama
- Kumlu cam sayesinde göz yormayan aydınlatma
- Dijital kontrol sayesinde hatasız algılama
- Ayarlanabilir zaman ve lux özelliği
- Sıva üstü kolay montaj
- LED aydınlatma özelliği ile daha fazla enerji tasarrufu
- Elektrik kesintisinde LED'li aydınlatma
- 3x1000mAh Ni-Mh Pili
- 2 saat acil aydınlatma süresi

Luminous Intensity Distribution Curve

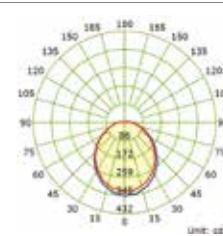

Illuminance at a Distance

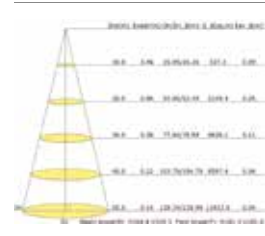

Vertical IsoLux Plot

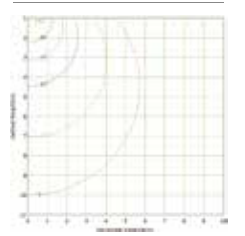

- 2800-3100K
- 4000-4500K
- 6000-6500K
- **Normal Yanma: 1200 Lm**
- **Acilde Yanma: 100 Lm**

Çalışma Gerilimi	Aydınlatma Şiddeti	Acil Aydınlatma Şiddeti	Algılama Etki Alanı	Algılama Yüksekliği	Zaman Ayarı	Gün Işığı Ayarı	Çalışma Sıcaklığı	Koruma Derecesi	Koli Bilgisi
230-240V - 50/60Hz	1200 LM	100 LM	360°	2.8 m	10 sn ~ 5 dk	2-2000 lux	-20°C ~ +40°C	IP 20	23 kg 8 Adet 82,00x60,00x41,00



TS EN 60669-2-1
TS EN 60598-2-1
CE



360° HAREKET SENSÖRLÜ LED'Lİ ACİL AYDINLATMALI TAVAN ARMATÜRÜ

SENSÖR VE SENSÖRLÜ AYDINLATMA SİSTEMLERİ

18W

10432 KROM

340,00 TL



SIVA ÜSTÜ

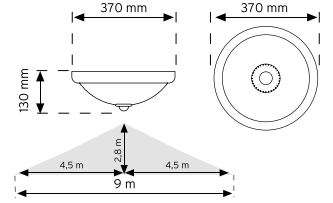

- LED'li aydınlatma sayesinde A sınıfı enerji tüketimi
- 360° hareket sensörü sayesinde her yönden algılama
- Kumlu cam sayesinde göz yormayan aydınlatma
- Dijital kontrol sayesinde hatasız algılama
- Ayarlanabilir zaman ve lux özelliği
- Sıva üstü kolay montaj
- LED aydınlatma özelliği ile daha fazla enerji tasarrufu
- Elektrik kesintisinde LED'li aydınlatma
- 3x1000mAh Ni-Mh Pili
- 2 saat acil aydınlatma süresi

Luminous Intensity Distribution Curve

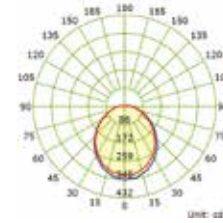

Illuminance at a Distance

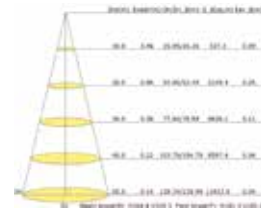

Vertical IsoLux Plot

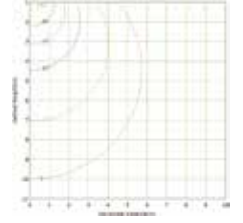

- 2800-3100K
- 4000-4500K
- 6000-6500K
- Normal Yanma: 1200 Lm
- Acilde Yanma: 100 Lm

Çalışma Gerilimi 230-240V - 50/60Hz	Aydınlatma Şiddeti LM 1200 LM	Acil Aydınlatma Şiddeti LM 100 LM	Algılama Etki Alanı 360° Max. 9 m ↔	Algılama Yüksekliği h 2.8 m	Zaman Ayarı 10 sn ~ 5 dk	Gün Işığı Ayarı 2-2000 lux	Çalışma Sıcaklığı -20°C ~ +40°C	Koruma Derecesi IP 20 I Sınıfı	Koli Bilgisi 23 kg 8 Adet 82,00x60,00x41,00
--	-------------------------------------	---	---	-----------------------------------	-----------------------------	-------------------------------	------------------------------------	--------------------------------------	--



TS EN 60669-2-1
TS EN 60598-2-1
CE



HF (RADAR) SENSÖRLÜ LED'Lİ ACİL AYDINLATMALI TAVAN ARMATÜRÜ

SENSÖR VE SENSÖRLÜ AYDINLATMA SİSTEMLERİ

18W

10951

295,00 TL



ACİL
AYDINLATMA



SIVA ÜSTÜ

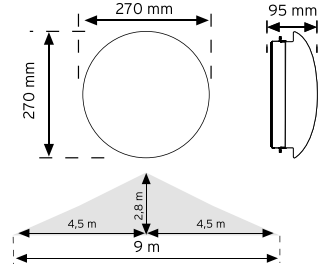

e-MOTION®

- LED'li aydınlatma sayesinde A sınıfı enerji tüketimi
- HF sensör teknolojisi sayesinde her yönden algılama
- Opal cam sayesinde göz yormayan aydınlatma
- Cam ve duvar arkasından algılama yapar
- Ayarlanabilir zaman ve lux özelliği
- Sıva üstü kolay montaj
- LED aydınlatma özelliği ile daha fazla enerji tasarrufu
- Elektrik kesintisinde LED'li aydınlatma
- 3x1000mAh Ni-Mh Pili
- 2 saat acil aydınlatma süresi

Luminous Intensity Distribution Curve

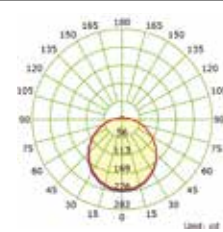

Illuminance at a Distance

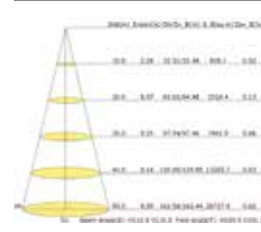

Vertical IsoLux Plot

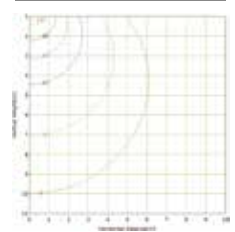

- 2800-3100K
- 4000-4500K
- 6000-6500K
- Normal Yanma 1150 Lm
- Acil'de Yanma 100 Lm

Çalışma Gerilimi	Aydınlatma Şiddeti	Acil Aydınlatma Şiddeti	Algılama Etki Alanı	Algılama Yüksekliği	Zaman Ayarı	Gün Işığı Ayarı	Çalışma Sıcaklığı	Koruma Derecesi	Koli Bilgisi
230-240V - 50/60Hz	1150 LM	100 LM	360°	2.8 m	10 sn ~ 30 dk	2-2000 lux	-20°C ~ +40°C	IP 20	17,5 kg 9 Adet 91,00x59,50x33,50



TS EN 60669-2-1
TS EN 60598-2-1



HF (RADAR) SENSÖRLÜ LED'Lİ TAVAN ARMATÜRÜ

SENSÖR VE SENSÖRLÜ AYDINLATMA SİSTEMLERİ

18W

10952

245,00 TL



SIVA ÜSTÜ

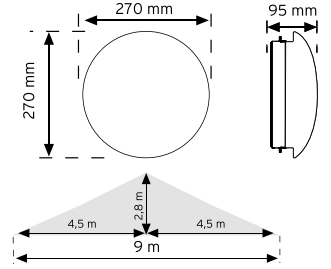

e-MOTION®

- LED'li aydınlatma sayesinde A sınıfı enerji tüketimi
- HF sensör teknolojisi sayesinde her yönden algılama
- Opal cam sayesinde göz yormayan aydınlatma
- Cam ve duvar arkasından algılama yapar
- Ayarlanabilir zaman ve lux özelliği
- Sıva üstü kolay montaj
- LED aydınlatma özelliği ile daha fazla enerji tasarrufu

Luminous Intensity Distribution Curve

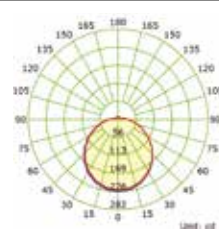

Illuminance at a Distance

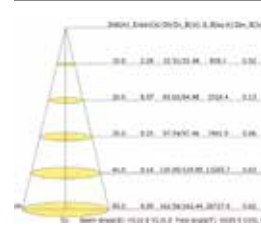

Vertical IsoLux Plot

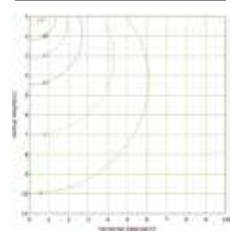

- 2800-3100K
- 4000-4500K
- 6000-6500K
- 1150 Lm

Çalışma Gerilimi 230-240V- 50/60Hz	Aydınlatma Şiddeti LM 1150 LM	Algılama Etki Alanı 360° 3 m - 9 m ↔	Algılama Yüksekliği 2.8 m	Zaman Ayarı 10 sn ~ 30 dk	Gün Işığın Ayarı 2-2000 lux	Çalışma Sıcaklığı -20°C ~ +40°C	Koruma Derecesi IP 20	Koli Bilgisi 17,5 Kg 9 Adet 91,00x59,50x33,50
---------------------------------------	-------------------------------------	--	------------------------------	------------------------------	--------------------------------	------------------------------------	--------------------------	---



TS EN 60669-2-1
TS EN 60598-2-1
CE



HF (RADAR) SENSÖRLÜ TAVAN ARMATÜRÜ

SENSÖR VE SENSÖRLÜ AYDINLATMA SİSTEMLERİ

10950

160,00 TL



SIVA ÜSTÜ

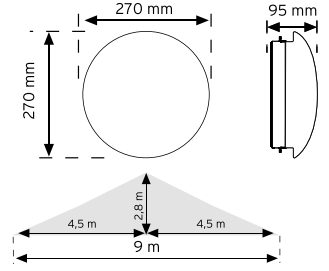

e-MOTION®

- HF sensör teknolojisi sayesinde her yönden algılama
- Opal cam sayesinde göz yormayan aydınlatma
- Cam ve duvar arkasından algılama yapar
- Ayarlanabilir zaman ve lux özelliği
- Sıva üstü kolay montaj

Çalışma Gerilimi	Aydınlatma Yüklü	Algılama Etki Alanı	Algılama Yüksekliği	Zaman Ayarı	Gün Işığı Ayarı	Çalışma Sıcaklığı	Koruma Derecesi	Koli Bilgisi
230-240V - 50/60Hz	1x60W E27	360°	2.8 m	10 sn ~ 30 dk	2-2000 lux	-20°C ~ +40°C	IP 20	19 kg 9 Adet 91,00x59,50x33,50



TS EN 60669-2-1
TS EN 60598-2-1
CE



360° HAREKET SENSÖRLÜ LED'Lİ ACİL AYDINLATMALI TAVAN ARMATÜRÜ

SENSÖR VE SENSÖRLÜ AYDINLATMA SİSTEMLERİ

15W

10710

320,00 TL



ACİL AYDINLATMA



SIVA ÜSTÜ

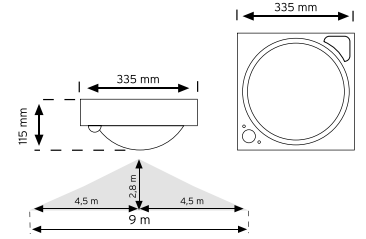

- LED'li aydınlatma sayesinde A sınıfı enerji tüketimi
- 360° hareket sensörü sayesinde her yönden algılama
- Kumlu cam sayesinde göz yormayan aydınlatma
- Dijital kontrol sayesinde hatasız algılama
- Ayarlanabilir zaman ve lüks özelliği
- Sıva üstü kolay montaj
- LED aydınlatma özelliği ile daha fazla enerji tasarrufu
- Elektrik kesintisinde LED'li aydınlatma
- 3x1000mAh Ni-Mh Pili
- 2 saat acil aydınlatma süresi

Luminous Intensity Distribution Curve

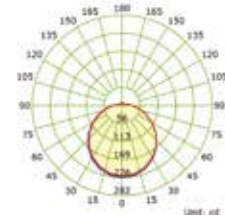

Illuminance at a Distance

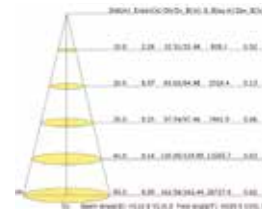

Vertical IsoLux Plot

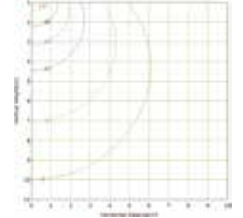

- 2800-3100K
- 4000-4500K
- 6000-6500K
- Normal Yanma 1050 Lm
- Acil'de Yanma 100 Lm

Çalışma Gerilimi 230-240V - 50/60Hz	Aydınlatma Şiddeti LM 1050 LM	Acil Aydınlatma Şiddeti LM 100 LM	Algılama Etki Alanı 360° Max. 9 m ↔	Algılama Yüksekliği h 2.8 m	Zaman Ayarı 10 sn ~ 5 dk	Gün Işığı Ayarı 2-2000 lux	Çalışma Sıcaklığı -20°C ~ +40°C	Pil Türü 3,6V Ni-Cd Şarjlı Pil	Koruma Derecesi IP 20	Koli Bilgisi 22 kg 8 Adet 70,00x46,50x41,00
--	-------------------------------------	---	---	-----------------------------------	-----------------------------	-------------------------------	------------------------------------	-----------------------------------	-----------------------------	--



TS EN 60669-2-1
TS EN 60598-2-1



360° HAREKET SENSÖRLÜ LED'Lİ ACİL AYDINLATMALI TAVAN ARMATÜRÜ

SENSÖR VE SENSÖRLÜ AYDINLATMA SİSTEMLERİ

15W

10710 GRİ

380,00 TL



ACİL AYDINLATMA



SIVA ÜSTÜ

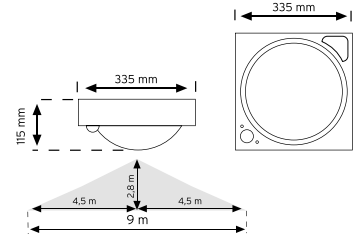

- LED'li aydınlatma sayesinde A sınıfı enerji tüketimi
- 360° hareket sensörü sayesinde her yönden algılama
- Kumlu cam sayesinde göz yormayan aydınlatma
- Metalik gri gövde
- Dijital kontrol sayesinde hatasız algılama
- Ayarlanabilir zaman ve lüks özelliği
- Sıva üstü kolay montaj
- LED aydınlatma özelliği ile daha fazla enerji tasarrufu
- Elektrik kesintisinde LED'li aydınlatma
- 3x1000mAh Ni-Mh Pili
- 2 saat acil aydınlatma süresi

Luminous Intensity Distribution Curve

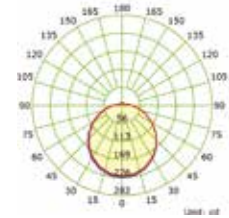

Illuminance at a Distance

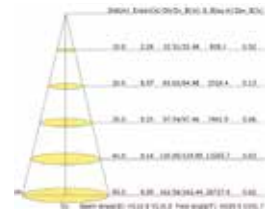

Vertical IsoLux Plot

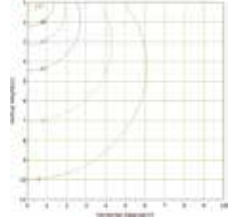

- 2800-3100K
- 4000-4500K
- 6000-6500K
- Normal Yanma 1050 Lm
- Acil'de Yanma 100 Lm

Çalışma Gerilimi	Aydınlatma Şiddeti	Acil Aydınlatma Şiddeti	Algılama Etki Alanı	Algılama Yüksekliği	Zaman Ayarı	Gün Işığı Ayarı	Çalışma Sıcaklığı	Pil Türü	Koruma Derecesi	Koli Bilgisi
230-240V - 50/60Hz	1050 LM	100 LM	360°	2.8 m	10 sn ~ 5 dk	2-2000 lux	-20°C ~ +40°C	3.6V Ni-Cd Şarjlı Pil	IP 20	22 kg 8 Adet 70,00x46,50x41,00



TS EN 60669-2-1
TS EN 60598-2-1



360° HAREKET SENSÖRLÜ LED'Lİ ACİL AYDINLATMALI TAVAN ARMATÜRÜ

SENSÖR VE SENSÖRLÜ AYDINLATMA SİSTEMLERİ

15W

10720

360,00 TL



ACİL AYDINLATMA



SIVA ÜSTÜ

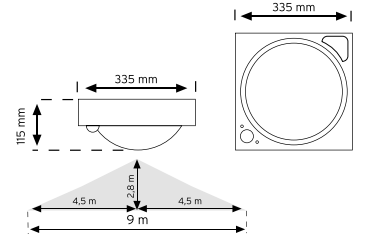

- LED'li aydınlatma sayesinde A sınıfı enerji tüketimi
- 360° hareket sensörü sayesinde her yönden algılama
- Kumlu cam sayesinde göz yormayan aydınlatma
- Dijital kontrol sayesinde hatasız algılama
- Ayarlanabilir zaman ve lüks özelliği
- Sıva üstü kolay montaj
- LED aydınlatma özelliği ile daha fazla enerji tasarrufu
- Elektrik kesintisinde LED'li aydınlatma
- 3x1000mAh Ni-Mh Pili
- 2 saat acil aydınlatma süresi

Luminous Intensity Distribution Curve

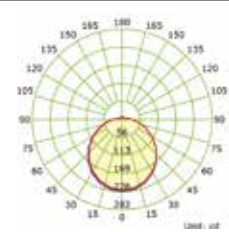

Illuminance at a Distance

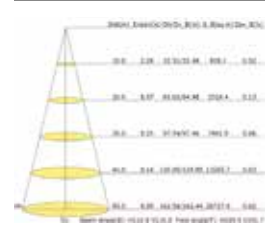

Vertical IsoLux Plot

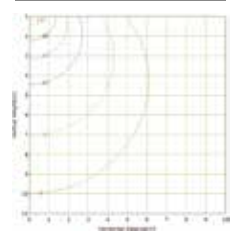

- 2800-3100K
- 4000-4500K
- 6000-6500K
- Normal Yanma 1050 Lm
- Acil'de Yanma 100 Lm

Çalışma Gerilimi 230-240V - 50/60Hz	Aydınlatma Şiddeti LM 1050 LM	Acil Aydınlatma Şiddeti LM 100 LM	Algılama Etki Alanı 360° Max. 9 m ↔	Algılama Yüksekliği h 2.8 m	Zaman Ayarı 10 sn ~ 5 dk	Gün Işığı Ayarı 2-2000 lux	Çalışma Sıcaklığı -20°C ~ +40°C	Pil Türü 3.6V Ni-Cd Şarjlı Pil	Koruma Derecesi IP 20	Koli Bilgisi 22 kg 8 Adet 70,00x46,50x41,00
--	-------------------------------------	---	---	-----------------------------------	-----------------------------	-------------------------------	------------------------------------	-----------------------------------	-----------------------------	--



TS EN 60669-2-1
TS EN 60598-2-1



360° HAREKET SENSÖRLÜ LED'Lİ ACİL AYDINLATMALI TAVAN ARMATÜRÜ

SENSÖR VE SENSÖRLÜ AYDINLATMA SİSTEMLERİ

RADAR SENSÖRLÜ AYDINLATMA (15W)

10720 GRİ

380,00 TL



ACİL
AYDINLATMA



SIVA ÜSTÜ

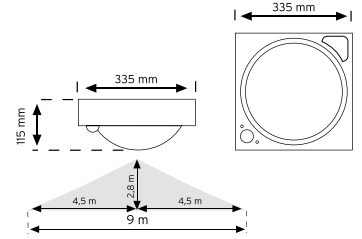

- LED'li aydınlatma sayesinde A sınıfı enerji tüketimi
- 360° hareket sensörü sayesinde her yönden algılama
- Kumlu cam sayesinde göz yormayan aydınlatma
- Metalik gri gövde
- Dijital kontrol sayesinde hatasız algılama
- Ayarlanabilir zaman ve lüks özelliği
- Sıva üstü kolay montaj
- LED aydınlatma özelliği ile daha fazla enerji tasarrufu
- Elektrik kesintisinde LED'li aydınlatma
- 3x1000mAh Ni-Mh Pil
- 2 saat acil aydınlatma süresi

Luminous Intensity Distribution Curve

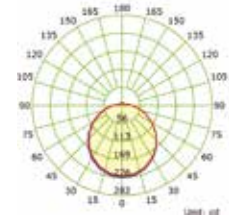

Illuminance at a Distance

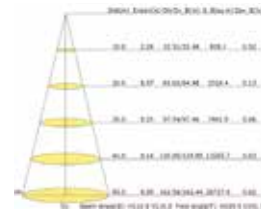

Vertical IsoLux Plot

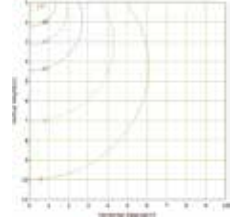

- 2800-3100K
- 4000-4500K
- 6000-6500K
- Normal Yanma 1050 Lm
- Acil'de Yanma 100 Lm

Çalışma Gerilimi	Aydınlatma Şiddeti	Acil Aydınlatma Şiddeti	Algılama Etki Alanı	Algılama Yüksekliği	Zaman Ayarı	Gün Işığı Ayarı	Çalışma Sıcaklığı	Pil Türü	Koruma Derecesi	Koli Bilgisi
230-240V - 50/60Hz	1050 LM	100 LM	360°	2.8 m	10 sn ~ 5 dk	2-2000 lux	-20°C ~ +40°C	3.6V Ni-Cd Şarjlı Pil	IP 20	22 kg 8 Adet 70,00x46,50x41,00



TS EN 60669-2-1
TS EN 60598-2-1



360° HAREKET SENSÖRLÜ LED'Lİ TAVAN ARMATÜRÜ

SENSÖR VE SENSÖRLÜ AYDINLATMA SİSTEMLERİ

18W

10410

310,00 TL



SIVA ÜSTÜ

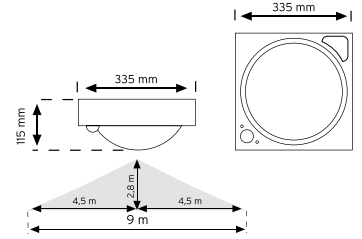

- LED'li aydınlatma sayesinde A sınıfı enerji tüketimi
- 360° hareket sensörü sayesinde her yönden algılama
- Kumlu cam sayesinde göz yormayan aydınlatma
- Dijital kontrol sayesinde hatasız algılama
- Ayarlanabilir zaman ve lüks özelliği
- Sıva üstü kolay montaj
- LED aydınlatma özelliği ile daha fazla enerji tasarrufu

Luminous Intensity Distribution Curve

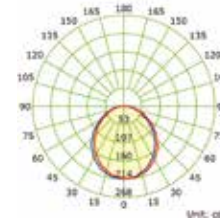

Illuminance at a Distance

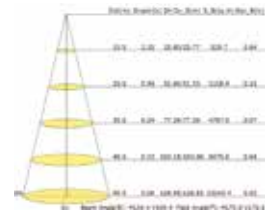

Vertical IsoLux Plot

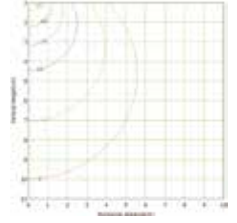

- 2800-3100K
- 4000-4500K
- 6000-6500K
- 1250 Lm

Çalışma Gerilimi 230-240V - 50/60Hz	Aydınlatma Şiddeti LM 1250 LM	Algılama Etki Alanı 360° Max. 9 m ↔	Algılama Yüksekliği h 2.8 m	Zaman Ayarı 10 sn ~ 5 dk	Gün Işığın Ayarı 2-2000 lux	Çalışma Sıcaklığı -20°C ~ +40°C	Pil Türü 3,6V Ni-Cd Şarjlı Pil	Koruma Derecesi IP 20	Koli Bilgisi 20 kg 8 Adet 70,00x46,50x41,00
--	-------------------------------------	---	-----------------------------------	-----------------------------	--------------------------------	------------------------------------	-----------------------------------	--------------------------	---



TS EN 60669-2-1
TS EN 60598-2-1
CE



360° HAREKET SENSÖRLÜ LED'Lİ TAVAN ARMATÜRÜ

SENSÖR VE SENSÖRLÜ AYDINLATMA SİSTEMLERİ

18W

10410 GRİ

340,00 TL



SIVA ÜSTÜ

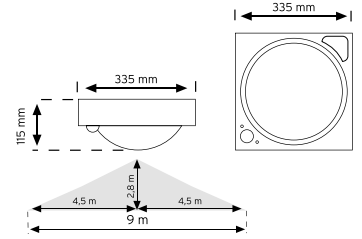

- LED'li aydınlatma sayesinde A sınıfı enerji tüketimi
- 360° hareket sensörü sayesinde her yönden algılama
- Kumlu cam sayesinde göz yormayan aydınlatma
- Dijital kontrol sayesinde hatasız algılama
- Ayarlanabilir zaman ve lüks özelliği
- Sıva üstü kolay montaj
- LED aydınlatma özelliği ile daha fazla enerji tasarrufu

Luminous Intensity Distribution Curve

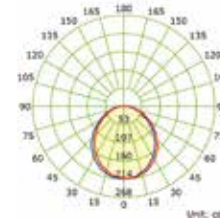

Illuminance at a Distance

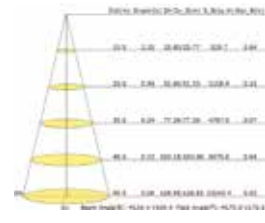

Vertical IsoLux Plot

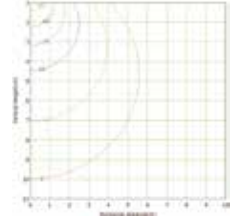

- 2800-3100K
- 4000-4500K
- 6000-6500K
- 1250 Lm

Çalışma Gerilimi 230-240V- 50/60Hz	Aydınlatma Şiddeti LM 1250 LM	Algılama Etki Alanı 360° Max. 9 m ↔	Algılama Yüksekliği h 2.8 m	Zaman Ayarı 10 sn ~ 5 dk	Gün Işığ Ayarı 2-2000 lux	Çalışma Sıcaklığı -20°C ~ +40°C	Pil Türü 3,6V Ni-Cd Şarjlı Pil	Koruma Derecesi IP 20 I Sınıfı	Koli Bilgisi 20 kg 8 Adet 70,00x46,50x41,00
---------------------------------------	-------------------------------------	---	-----------------------------------	-----------------------------	------------------------------	------------------------------------	-----------------------------------	--------------------------------------	---



TS EN 60669-2-1
TS EN 60598-2-1
CE



360° HAREKET SENSÖRLÜ ACİL AYDINLATMALI TAVAN ARMATÜRÜ

SENSÖR VE SENSÖRLÜ AYDINLATMA SİSTEMLERİ

10700

230,00 TL

ACİL
AYDINLATMA



SIVA ÜSTÜ

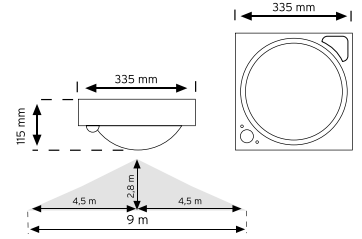

- 360° hareket sensörü sayesinde her yönden algılama
 - Kumlu cam sayesinde göz yormayan aydınlatma
 - Dijital kontrol sayesinde hatasız algılama
 - Ayarlanabilir zaman ve lüks özelliği
 - Sıva üstü kolay montaj
 - Elektrik kesintisinde LED'li acil aydınlatma
 - 3x1000mAh Ni-Mh Pili
 - 2 saat acil aydınlatma süresi
- Acil'de yanma : 100 Lm

Çalışma Gerilimi	Aydınlatma Yüklü	Acil Aydınlatma Şiddeti	Algılama Etki Alanı	Algılama Yüksekliği	Zaman Ayarı	Gün Işığı Ayarı	Pil Türü	Acil Aydınlatma	Acil Aydınlatma Şiddeti	Çalışma Sıcaklığı
230-240V - 50/60Hz	1x60W E27	100 LM	360°	2.8 m	10 sn ~ 5 dk	2-2000 lux	3,6V Ni-Cd Şarjlı Pil	12x2000 mcd 120°	20 LM	-20°C ~ +40°C



TS EN 60669-2-1
TS EN 60598-2-1



Koruma Derecesi	Koli Bilgisi
IP 20 I Sınıfı	21 kg 8 Adet 70,00x46,50x41,00

360° HAREKET SENSÖRLÜ ACİL AYDINLATMALI TAVAN ARMATÜRÜ

SENSÖR VE SENSÖRLÜ AYDINLATMA SİSTEMLERİ

10700 GRİ

260,00 TL

ACİL
AYDINLATMA



SIVA ÜSTÜ

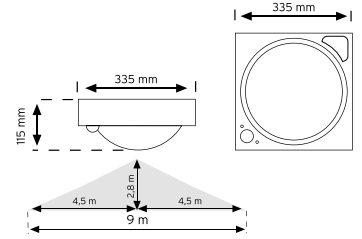

- 360° hareket sensörü sayesinde her yönden algılama
- Kumlu cam sayesinde göz yormayan aydınlatma
- Dijital kontrol sayesinde hatasız algılama
- Ayarlanabilir zaman ve lüks özelliği
- Sıva üstü kolay montaj
- Elektrik kesintisinde LED'li acil aydınlatma
- 3x1000mAh Ni-Mh Pili
- 2 saat acil aydınlatma süresi
- Acil'de yanma : 100 Lm

Çalışma Gerilimi	Aydınlatma Yüklü	Acil Aydınlatma Şiddeti	Algılama Etki Alanı	Algılama Yüksekliği	Zaman Ayarı	Gün Işığı Ayarı	Pil Türü	Acil Aydınlatma	Acil Aydınlatma Şiddeti	Çalışma Sıcaklığı
230-240V-50/60Hz	1x60W E27	100 LM	360°	2.8 m	10 sn ~ 5 dk	2-2000 lux	3,6V Ni-Cd Şarjlı Pil	12x2000 mcd 120°	20 LM	-20°C ~ +40°C



Koruma Derecesi	Koli Bilgisi
IP 20 I Sınıfı	21 kg 8 Adet 70,00x46,50x41,00

360° HAREKET SENSÖRLÜ TAVAN ARMATÜRÜ

SENSÖR VE SENSÖRLÜ AYDINLATMA SİSTEMLERİ

10400



160,00 TL

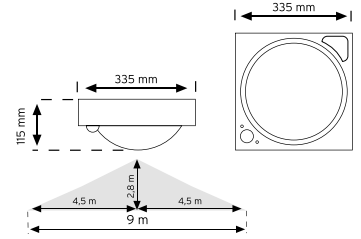

SIVA ÜSTÜ



- 360° hareket sensörü sayesinde her yönden algılama
- Kumlu cam sayesinde göz yormayan aydınlatma
- Dijital kontrol sayesinde hatasız algılama
- Ayarlanabilir zaman ve lüks özelliği
- Sıva üstü kolay montaj

Çalışma Gerilimi	Aydınlatma Yüklü	Algılama Etki Alanı	Algılama Yüksekliği	Zaman Ayarı	Gün Işığ Ayarı	Çalışma Sıcaklığı	Koruma Derecesi	Koli Bilgisi
 230-240V - 50/60Hz	 1x60W E27	 Max. 9 m ↔	 2.8 m	 10 sn ~ 5 dk	 2-2000 lux	 -20°C ~ +40°C	 I Sınıfı	 18 kg 8 Adet 70,00x46,50x41,00



TS EN 60669-2-1
TS EN 60598-2-1



360° HAREKET SENSÖRLÜ TAVAN ARMATÜRÜ

SENSÖR VE SENSÖRLÜ AYDINLATMA SİSTEMLERİ

10400 GRİ

190,00 TL



SIVA ÜSTÜ

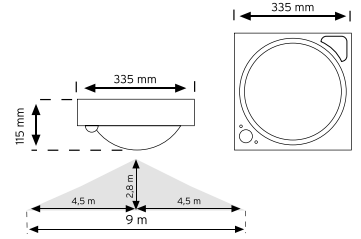

- 360° hareket sensörü sayesinde her yönden algılama
- Kumlu cam sayesinde göz yormayan aydınlatma
- Dijital kontrol sayesinde hatasız algılama
- Ayarlanabilir zaman ve lüks özelliği
- Sıva üstü kolay montaj

Çalışma Gerilimi	Aydınlatma Yüklü	Algılama Etki Alanı	Algılama Yüksekliği	Zaman Ayarı	Gün Işığı Ayarı	Çalışma Sıcaklığı	Koruma Derecesi	Koli Bilgisi
230-240V - 50/60Hz	1x60W E27	360° Max. 9 m ↔	2.8 m	10 sn ~ 5 dk	2-2000 lux	-20°C ~ +40°C	IP 20 I Sınıfı	18 kg 8 Adet 70,00x46,50x41,00



TS EN 60669-2-1
TS EN 60598-2-1



180° 3 HAREKET SENSÖRLÜ LED'Lİ DUVAR ARMATÜRÜ

SENSÖR VE SENSÖRLÜ AYDINLATMA SİSTEMLERİ

10W

10820

245,00 TL



SIVA ÜSTÜ

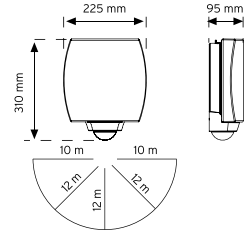

e-MOTION®

- LED'li aydınlatma sayesinde A sınıfı enerji tüketimi
- 3 gözlü sensörü sayesinde her yönden algılama
- Opal cam sayesinde göz yormayan aydınlatma
- Dijital kontrol sayesinde hatasız algılama
- Ayarlanabilir zaman ve lüks özelliği
- Sıva üstü kolay montaj
- LED aydınlatma özelliği ile daha fazla enerji tasarrufu

Luminous Intensity Distribution Curve

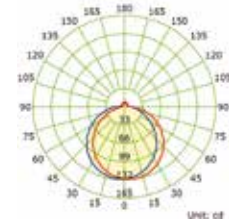

Illuminance at a Distance



Vertical IsoLux Plot

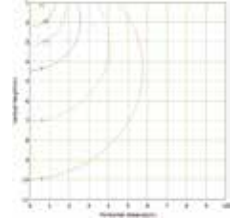

- 2800-3100K
- 4000-4500K
- 6000-6500K
- 550 Lm

Çalışma Gerilimi 230-240V - 50/60Hz	Aydınlatma Şiddeti 550 LM	Algılama Etki Alanı 3 - 12 m →	Algılama Yüksekliği 2.2 m	Zaman Ayarı 10 sn ~ 5 dk	Gün Işığın Ayarı 2-2000 lux	Çalışma Sıcaklığı -20°C ~ +40°C	Pil Türü 3,6V Ni-Cd Şarjlı Pil	Koruma Derecesi IP 43	Koli Bilgisi 15 kg 8 Adet 78,00x51,50x31,00
--	------------------------------	-----------------------------------	------------------------------	-----------------------------	--------------------------------	------------------------------------	-----------------------------------	--------------------------	---



TS EN 60669-2-1
TS EN 60598-2-1
CE



180° 3 HAREKET SENSÖRLÜ ACİL AYDINLATMALI LED'Lİ DUVAR ARMATÜRÜ

SENSÖR VE SENSÖRLÜ AYDINLATMA SİSTEMLERİ

10W

10840

300,00 TL



ACİL AYDINLATMA



SIVA ÜSTÜ

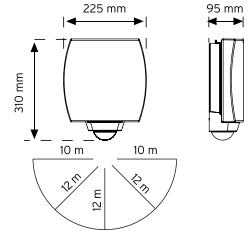

e-MOTION®

- LED'li aydınlatma sayesinde A sınıfı enerji tüketimi
- 3 gözlü sensörü sayesinde her yönden algılama
- Opal cam sayesinde göz yormayan aydınlatma
- Dijital kontrol sayesinde hatasız algılama
- Ayarlanabilir zaman ve lüks özelliği
- Sıva üstü kolay montaj
- LED aydınlatma özelliği ile daha fazla enerji tasarrufu
- Elektrik kesintisinde LED'li aydınlatma
- 3x1000mAh Ni-Mh Pil
- 2 saat acil aydınlatma süresi

Luminous Intensity Distribution Curve

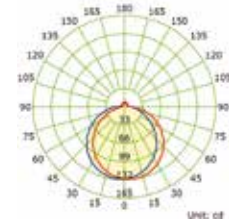

Illuminance at a Distance



Vertical IsoLux Plot

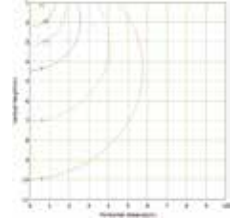

- 2800-3100K
- 4000-4500K
- 6000-6500K
- Normalde yanma 550 Lm
- Acil'de yanma 70 Lm

Çalışma Gerilimi	Aydınlatma Şiddeti	Acil Aydınlatma Şiddeti	Algılama Etki Alanı	Algılama Yüksekliği	Zaman Ayarı	Gün Işığı Ayarı	Çalışma Sıcaklığı	Pil Türü	Koruma Derecesi	Koli Bilgisi
230-240V - 50/60Hz	LM	LM	180°	2.2 m	10 sn ~ 5 dk	2-2000 lux	-20°C ~ +40°C	Pil Türü	IP 43	15 kg 8 Adet 78,00x51,50x31,00



TS EN 60669-2-1
TS EN 60598-2-1



180° 3 HAREKET SENSÖRLÜ DUVAR ARMATÜRÜ

SENSÖR VE SENSÖRLÜ AYDINLATMA SİSTEMLERİ

10800

230,00 TL

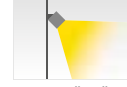

SIVA ÜSTÜ

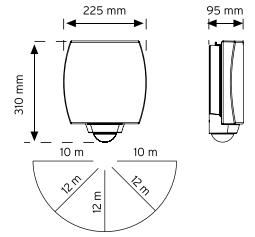

e-MOTION®

- 3 gözlü sensörü sayesinde her yönden algılama
- Opal cam sayesinde göz yormayan aydınlatma
- Dijital kontrol sayesinde hatasız algılama
- Ayarlanabilir zaman ve lüks özelliği
- Sıva üstü kolay montaj

Çalışma Gerilimi	Aydınlatma Yüklü	Algılama Etki Alanı	Algılama Yüksekliği	Zaman Ayarı	Gün Işığın Ayarı	Çalışma Sıcaklığı	Koruma Derecesi	Koli Bilgisi
230-240V - 50/60Hz	1 x 60 W E27	180° 3 - 12 m →	2.2 m	10 sn ~ 5 dk	2-2000 lux	-20°C ~ +40°C	IP 43	16,5 kg 8 Adet 78,00x51,50x31,00



TS EN 60669-2-1
TS EN 60598-2-1
CE



110° HAREKET SENSÖRLÜ LED'Lİ DUVAR ARMATÜRÜ







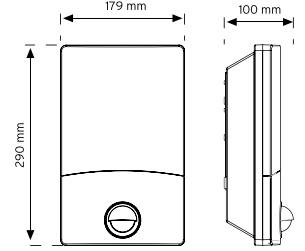

SENSÖR VE SENSÖRLÜ AYDINLATMA SİSTEMLERİ

10201

110,00 TL



- 3 gözlü sensörü sayesinde her yönden algılama
- Opal cam sayesinde göz yormayan aydınlatma
- Dijital kontrol sayesinde hatasız algılama
- Ayarlanabilir zaman ve lüks özelliği
- Sıva üstü kolay montaj

Çalışma Gerilimi	Aydınlatma Yüklü	Algılama Etki Alanı	Algılama Yüksekliği	Zaman Ayarı	Gün Işığı Ayarı	Çalışma Sıcaklığı	Koruma Derecesi
 230-240V - 50/60Hz	 23W Helişen/40W Akor Plafon	 11 m →	 2.2 m	 10 sn ~ 5,5 dk	 2-2000 lux	 -20°C ~ +40°C	 II Sınıfı



110° HAREKET SENSÖRLÜ LED'Lİ DUVAR ARMATÜRÜ

SENSÖR VE SENSÖRLÜ AYDINLATMA SİSTEMLERİ

12W

10211

195,00 TL

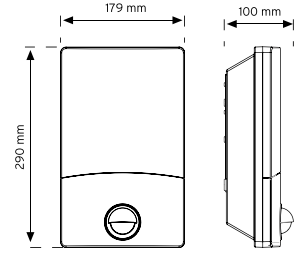

- LED'li aydınlatma sayesinde A sınıfı enerji tüketimi
- 3 gözlü sensörü sayesinde her yönden algılama
- Opal cam sayesinde göz yormayan aydınlatma
- Dijital kontrol sayesinde hatasız algılama
- Ayarlanabilir zaman ve lüks özelliği
- Sıva üstü kolay montaj
- LED aydınlatma özelliği ile daha fazla enerji tasarrufu

Luminous Intensity Distribution Curve

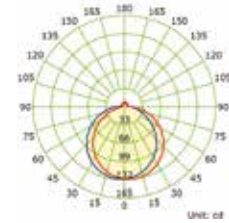

Illuminance at a Distance



Vertical IsoLux Plot

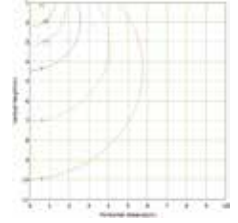

- 2800-3100K
- 4000-4500K
- 6000-6500K

- Normalde yanma 550 Lm
- Acil'de yanma 70 Lm

Çalışma Gerilimi 230-240V - 50/60Hz	Aydınlatma Şiddeti LM 121 LM	Algılama Etki Alanı 180° 3 - 12 m →	Algılama Yüksekliği h 2.2 m	Zaman Ayarı 10 sn ~ 5 dk	Gün Işığ Ayarı 2-2000 lux	Çalışma Sıcaklığı -20°C ~ +40°C	Koruma Derecesi IP 43	Koli Bilgisi 15 kg 8 Adet 78,00x51,50x31,00
--	------------------------------------	---	-----------------------------------	-----------------------------	------------------------------	------------------------------------	-----------------------------	---



TS EN 60669-2-1
TS EN 60598-2-1
CE

360° HAREKET SENSÖRLÜ TAVAN ARMATÜRÜ

SENSÖR VE SENSÖRLÜ AYDINLATMA SİSTEMLERİ

00999

55,00 TL



SIVA ÜSTÜ

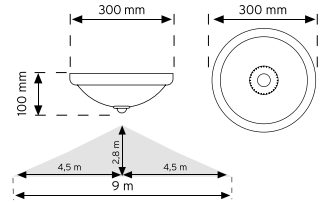

sensor**PLUS**

- 360° hareket sensörü sayesinde her yönden algılama
- Kumlu cam sayesinde göz yormayan aydınlatma
- Dijital kontrol sayesinde hatasız algılama
- Ayarlanabilir zaman ve lux özelliği
- Sıva üstü kolay montaj

Çalışma Gerilimi	Aydınlatma Yüklü	Algılama Etki Alanı	Algılama Yüksekliği	Zaman Ayarı	Gün Işığı Ayarı	Çalışma Sıcaklığı	Koruma Derecesi	Koli Bilgisi
230-240V - 50/60Hz	2 x 25 W E27	360° Max. 9 m ↔	2.8 m	10 sn ~ 5 dk	2-2000 lux	-20°C ~ +40°C	IP 20 I Sınıfı	17 kg 14 Adet 70,00x62,00x34,00



360° HAREKET SENSÖRLÜ TAVAN ARMATÜRÜ

SENSÖR VE SENSÖRLÜ AYDINLATMA SİSTEMLERİ

00999 KROM

85,00 TL





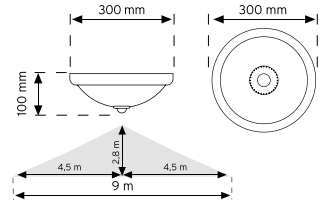





SIVA ÜSTÜ



sensor**PLUS**®

- 360° hareket sensörü sayesinde her yönden algılama
- Kumlu cam sayesinde göz yormayan aydınlatma
- Dijital kontrol sayesinde hatasız algılama
- Ayarlanabilir zaman ve lux özelliği
- Sıva üstü kolay montaj

Çalışma Gerilimi	Aydınlatma Yüklü	Algılama Etki Alanı	Algılama Yüksekliği	Zaman Ayarı	Gün Işığı Ayarı	Çalışma Sıcaklığı	Koruma Derecesi	Koli Bilgisi
 230-240V - 50/60Hz	 2 x 25 W E27	 Max. 9 m ↔	 2.8 m	 10 sn ~ 5 dk	 2-2000 lux	 -20°C ~ +40°C	 I Sınıfı	 17 kg 14 Adet 70,00x62,00x34,00



TS EN 60669-2-1
TS EN 60598-2-1
CE



360° HAREKET SENSÖRLÜ ACİL AYDINLATMALI LED'Lİ TAVAN ARMATÜRÜ

SENSÖR VE SENSÖRLÜ AYDINLATMA SİSTEMLERİ

00777

125,00 TL

ACİL
AYDINLATMA



SIVA ÜSTÜ

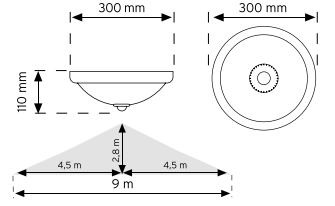

- 360° hareket sensörü sayesinde her yönden algılama
- Kumlu cam sayesinde göz yormayan aydınlatma
- Dijital kontrol sayesinde hatasız algılama
- Ayarlanabilir zaman ve lux özelliği
- Sıva üstü kolay montaj
- Elektrik kesintisinde LED'li aydınlatma
- 3x1000mAh Ni-Mh Pil
- 2 saat acil aydınlatma süresi
- Acil'de yanma: 60 Lm

Çalışma Gerilimi	Aydınlatma Yüklü	Acil Aydınlatma Şiddeti	Algılama Etki Alanı	Algılama Yüksekliği	Zaman Ayarı	Gün Işığı Ayarı	Çalışma Sıcaklığı	Koruma Derecesi	Koli Bilgisi
230-240V - 50/60Hz	2 x 25 W E27	60 LM	360°	2.8 m	10 sn ~ 5 dk	2-2000 lux	-20°C ~ +40°C	IP 20	17 kg 14 Adet 71,50x62,00x33,00



TS EN 60669-2-1
TS EN 60598-2-1
CE



360° HAREKET SENSÖRLÜ ACİL AYDINLATMALI LED'Lİ TAVAN ARMATÜRÜ

SENSÖR VE SENSÖRLÜ AYDINLATMA SİSTEMLERİ

00777 KROM

155,00 TL

ACİL
AYDINLATMA



SIVA ÜSTÜ

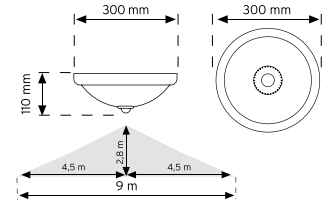

- 360° hareket sensörü sayesinde her yönden algılama
- Kumlu cam sayesinde göz yormayan aydınlatma
- Dijital kontrol sayesinde hatasız algılama
- Ayarlanabilir zaman ve lux özelliği
- Sıva üstü kolay montaj
- Elektrik kesintisinde LED'li aydınlatma
- 3x1000mAh Ni-Mh Pil
- 2 saat acil aydınlatma süresi
- Acil'de yanma: 60 Lm

Çalışma Gerilimi	Aydınlatma Yüklü	Acil Aydınlatma Şiddeti	Algılama Etki Alanı	Algılama Yüksekliği	Zaman Ayarı	Gün Işığı Ayarı	Çalışma Sıcaklığı	Koruma Derecesi	Koli Bilgisi
230-240V - 50/60Hz	2 x 25 W E27	60 LM	Max. 9 m ↔	2.8 m	10 sn ~ 5 dk	2-2000 lux	-20°C ~ +40°C	IP 20	17 kg 14 Adet 71,50x62,00x33,00



TS EN 60669-2-1
TS EN 60598-2-1
CE



360° HAREKET SENSÖRLÜ TAVAN ARMATÜRÜ

SENSÖR VE SENSÖRLÜ AYDINLATMA SİSTEMLERİ

10330

80,00 TL



SIVA ÜSTÜ

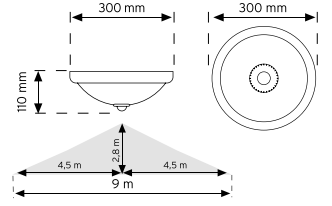

- 360° hareket sensörü sayesinde her yönden algılama
- Kumlu cam sayesinde göz yormayan aydınlatma
- Dijital kontrol sayesinde hatasız algılama
- Ayarlanabilir zaman ve lux özelliği
- Sıva üstü kolay montaj

Çalışma Gerilimi	Aydınlatma Yüklü	Algılama Etki Alanı	Algılama Yüksekliği	Zaman Ayarı	Gün Işığı Ayarı	Çalışma Sıcaklığı	Koruma Derecesi	Koli Bilgisi
230-240V - 50/60Hz	2 x 25 W E27	360° Max. 9 m ↔	2.8 m	10 sn ~ 5 dk	2-2000 lux	-20°C ~ +40°C	IP 20 I Sınıfı	17 kg 14 Adet 63.50x59.50x32.50



360° HAREKET SENSÖRLÜ TAVAN ARMATÜRÜ

SENSÖR VE SENSÖRLÜ AYDINLATMA SİSTEMLERİ

10330 KROM

110,00 TL



SIVA ÜSTÜ

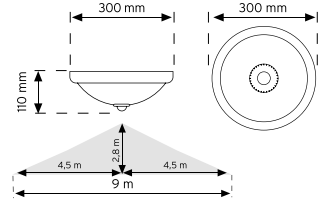

- 360° hareket sensörü sayesinde her yönden algılama
- Kumlu cam sayesinde göz yormayan aydınlatma
- Dijital kontrol sayesinde hatasız algılama
- Ayarlanabilir zaman ve lux özelliği
- Sıva üstü kolay montaj

Çalışma Gerilimi	Aydınlatma Yüğü	Algılama Etki Alanı	Algılama Yüksekliği	Zaman Ayarı	Gün Işığı Ayarı	Çalışma Sıcaklığı	Koruma Derecesi	Koli Bilgisi
230-240V - 50/60Hz	2 x 25 W E27	360° Max. 9 m ↔	2.8 m	10 sn ~ 5 dk	2-2000 lux	-20°C ~ +40°C	IP 20 I Sınıfı	17 kg 14 Adet 63.50x69.50x32.50



360° HAREKET SENSÖRLÜ TAVAN ARMATÜRÜ

SENSÖR VE SENSÖRLÜ AYDINLATMA SİSTEMLERİ

10430

120,00 TL



SIVA ÜSTÜ

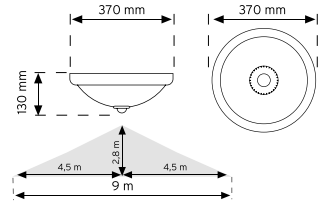

- 360° hareket sensörü sayesinde her yönden algılama
- Kumlu cam sayesinde göz yormayan aydınlatma
- Dijital kontrol sayesinde hatasız algılama
- Ayarlanabilir zaman ve lux özelliği
- Sıva üstü kolay montaj

Çalışma Gerilimi	Aydınlatma Yüklü	Algılama Etki Alanı	Algılama Yüksekliği	Zaman Ayarı	Gün Işığı Ayarı	Çalışma Sıcaklığı	Koruma Derecesi	Koli Bilgisi
230-240V - 50/60Hz	2 x 40 W E27	360° Max. 9 m ↔	2.8 m	10 sn ~ 5 dk	2-2000 lux	-20°C ~ +40°C	IP 20 I Sınıfı	24 kg 8 Adet 82,00x60,00x41,00



360° HAREKET SENSÖRLÜ TAVAN ARMATÜRÜ

SENSÖR VE SENSÖRLÜ AYDINLATMA SİSTEMLERİ

10430 KROM







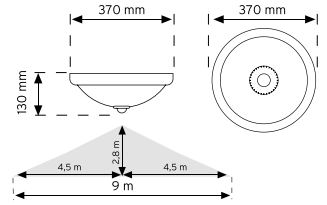

150,00 TL



SIVA ÜSTÜ



- 360° hareket sensörü sayesinde her yönden algılama
- Kumlu cam sayesinde göz yormayan aydınlatma
- Dijital kontrol sayesinde hatasız algılama
- Ayarlanabilir zaman ve lux özelliği
- Sıva üstü kolay montaj

Çalışma Gerilimi	Aydınlatma Yüğü	Algılama Etki Alanı	Algılama Yüksekliği	Zaman Ayarı	Gün Işığı Ayarı	Çalışma Sıcaklığı	Koruma Derecesi	Koli Bilgisi
 230-240V - 50/60Hz	 2 x 40 W E27	 Max. 9 m ↔	 2.8 m	 10 sn ~ 5 dk	 2-2000 lux	 -20°C ~ +40°C	 I Sınıfı	 24 kg 8 Adet 82,00x60,00x41,00



TS EN 60669-2-1
TS EN 60598-2-1
CE



360° TAVAN TİPİ TRIO SENSÖR

SENSÖR VE SENSÖRLÜ AYDINLATMA SİSTEMLERİ

VARLIK SENSÖRÜ

10500

240,00 TL

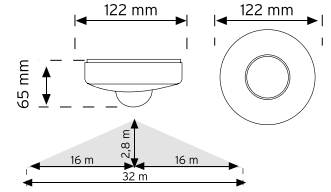

- Kişi ortamda bulunduğu sürece lambayı yakar
- 3 gözlü sensör teknolojisi sayesinde her yönden algılama yapar
- Açı ayarı ile 180°/360° seçenekleri
- Sıva üstü kolay montaj
- Uzaktan kumanda ile zaman, lux ve mesafe ayarları
- 32m. algılama mesafesi
- Geliştirilmiş dijital sinyal işleme yazılımı ve güçlü mikro işlemci sayesinde ortam sıcaklığı, hassasiyet ve parazitlerden etkilenmeden çalışma
- Sıcaklık kompanzasyonu ile 4 mevsim kararlı çalışma
- Işıklı uyarı

Çalışma Gerilimi	Aydınlatma Yüklü	Algılama Etki Alanı	Algılama Yüksekliği	Zaman Ayarı	Gün Işığın Ayarı	Çalışma Sıcaklığı	Koruma Derecesi
230-240V - 50/60Hz	2000 W / 800 W	360°	2.8 m	3 dk ~ 30 dk	2-2000 lux	-20°C ~ +40°C	IP 20



360° TAVAN TİPİ HAREKET SENSÖRÜ

SENSÖR VE SENSÖRLÜ AYDINLATMA SİSTEMLERİ

10463

145,00 TL

e-MOTION®



- 3 gözlü sensör teknolojisi sayesinde her yönden algılama
- Açı ayarı ile 180°/360° seçenekleri
- Sıva üstü kolay montaj
- Ayarlanabilir zaman, lux ve mesafe özelliği
- Dijital kontrol sayesinde hatasız algılama
- 24m. algılama mesafesi

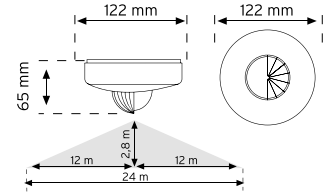

Çalışma Gerilimi	Aydınlatma Yüğü	Algılama Etki Alanı	Algılama Yüksekliği	Zaman Ayarı	Gün Işığı Ayarı	Çalışma Sıcaklığı	Koruma Derecesi
230-240V - 50/60Hz	2000 W / 800 W	6 - 24 m ↔	2.8 m	10 sn ~ 5 dk	2-2000 lux	-20°C ~ +40°C	II Sınıfı



10465

180,00 TL

e-MOTION®



- 3 gözlü sensör teknolojisi sayesinde her yönden algılama
- Açı ayarı ile 180°/360° seçenekleri
- Sıva altı kolay montaj
- Ayarlanabilir zaman, lux ve mesafe özelliği
- Dijital kontrol sayesinde hatasız algılama
- 24m. algılama mesafesi

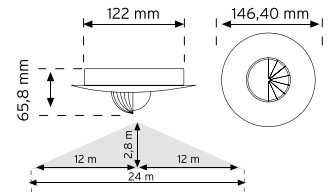

Çalışma Gerilimi	Aydınlatma Yüğü	Algılama Etki Alanı	Algılama Yüksekliği	Zaman Ayarı	Gün Işığı Ayarı	Montaj Kesim Çapı	Çalışma Sıcaklığı	Koruma Derecesi
230-240V - 50/60Hz	2000 W / 800 W	6 - 24 m ↔	2.8 m	10 sn ~ 5 dk	2-2000 lux	Ø130 mm	-20°C ~ +40°C	II Sınıfı



360° TAVAN TİPİ HAREKET SENSÖRÜ

SENSÖR VE SENSÖRLÜ AYDINLATMA SİSTEMLERİ

10464

120,00 TL

e-MOTION®



- 360° algılama açısı
- Sıva üstü kolay montaj
- Ayarlanabilir zaman, lux ve mesafe özelliği
- Dijital kontrol sayesinde hatasız algılama

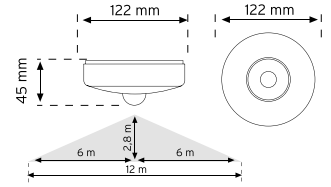

Çalışma Gerilimi	Aydınlatma Yüğü	Algılama Etki Alanı	Algılama Yüksekliği	Zaman Ayarı	Gün Işığı Ayarı	Çalışma Sıcaklığı	Koruma Derecesi
230-240V - 50/60Hz	2000 W / 800 W	360°	2.8 m	10 sn ~ 5 dk	2-2000 lux	-20°C ~ +40°C	IP 20



10466

120,00 TL

e-MOTION®



- 360° algılama açısı
- Sıva altı kolay montaj
- Ayarlanabilir zaman, lux ve mesafe özelliği
- Dijital kontrol sayesinde hatasız algılama

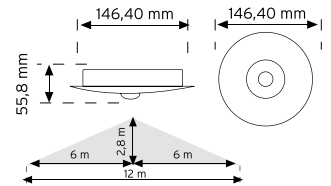

Çalışma Gerilimi	Aydınlatma Yüğü	Algılama Etki Alanı	Algılama Yüksekliği	Zaman Ayarı	Gün Işığı Ayarı	Çalışma Sıcaklığı	Koruma Derecesi
230-240V - 50/60Hz	2000 W / 800 W	360°	2.8 m	10 sn ~ 5 dk	2-2000 lux	-20°C ~ +40°C	IP 20



360° TAVAN TİPİ HAREKET SENSÖRÜ - (KORİDOR SENSÖR)

SENSÖR VE SENSÖRLÜ AYDINLATMA SİSTEMLERİ

10467

145,00 TL

e-MOTION®



- Sıva üstü kolay montaj
- Ayarlanabilir zaman, lux ve mesafe özelliği
- Dijital kontrol sayesinde hatasız algılama
- 32m. algılama mesafesi

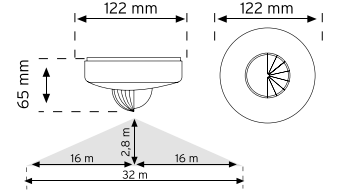

Çalışma Gerilimi	Aydınlatma Yüğü	Algılama Etki Alanı	Algılama Yüksekliği	Zaman Ayarı	Gün Işığı Ayarı	Çalışma Sıcaklığı	Koruma Derecesi
230-240V - 50/60Hz	2000 W / 800 W	6 - 32 m ↔	2.8 m	10 sn ~ 5 dk	2-2000 lux	-20°C ~ +40°C	II Sınıfı



10468

150,00 TL

e-MOTION®



- Sıva altı kolay montaj
- Ayarlanabilir zaman, lux ve mesafe özelliği
- Dijital kontrol sayesinde hatasız algılama
- 32m. algılama mesafesi

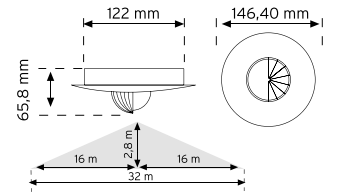

Çalışma Gerilimi	Aydınlatma Yüğü	Algılama Etki Alanı	Algılama Yüksekliği	Zaman Ayarı	Gün Işığı Ayarı	Çalışma Sıcaklığı	Koruma Derecesi
230-240V - 50/60Hz	2000 W / 800 W	6 - 32 m ↔	2.8 m	10 sn ~ 5 dk	2-2000 lux	-20°C ~ +40°C	II Sınıfı



360° TAVAN TİPİ HAREKET SENSÖRÜ

SENSÖR VE SENSÖRLÜ AYDINLATMA SİSTEMLERİ

10360

70,00 TL



- 360° algılama açısı
- Sıva üstü kolay montaj
- Ayarlanabilir zaman ve lux özelliği
- Dijital kontrol sayesinde hatasız algılama

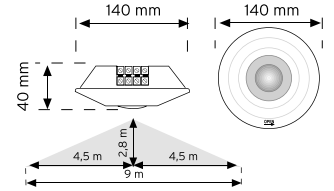

 Çalışma Gerilimi 230-240V - 50/60Hz	 Aydınlatma Yüğü 1000 W / 400 W	 Algılama Etki Alanı Max. 9 m ↔	 Algılama Yüksekliği 2.8 m	 Zaman Ayarı 5 sn ~ 5 dk	 Gün Işığı Ayarı 2-2000 lux	 Çalışma Sıcaklığı -20°C ~ +40°C	 Koruma Derecesi II Sınıfı	 Koli Bilgisi 8 kg 32 Adet 44,50x30,00x31,00
---	--	--	---	---	--	---	--	--



10359

68,00 TL



- 360° algılama açısı
- Sıva altı kolay montaj
- Ayarlanabilir zaman ve lux özelliği
- Dijital kontrol sayesinde hatasız algılama

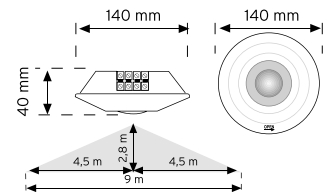

 Çalışma Gerilimi 230-240V - 50/60Hz	 Aydınlatma Yüğü 1000 W / 400 W	 Algılama Etki Alanı Max. 9 m ↔	 Algılama Yüksekliği 2.8 m	 Zaman Ayarı 5 sn ~ 5 dk	 Gün Işığı Ayarı 2-2000 lux	 Montaj Kesim Çapı Ø130 mm	 Çalışma Sıcaklığı -20°C ~ +40°C	 Koruma Derecesi II Sınıfı	 Koli Bilgisi 6 kg 24 Adet 44,50x30,50x32,00
---	--	--	---	---	--	---	--	---	--



360° HAREKET SENSÖRÜ

SENSÖR VE SENSÖRLÜ AYDINLATMA SİSTEMLERİ

10361

75,00 TL



- 360° algılama açısı
- 360° dönebilen gövde
- Sıva üstü kolay montaj
- Ayarlanabilir zaman ve lux özelliği
- Dijital kontrol sayesinde hatasız algılama

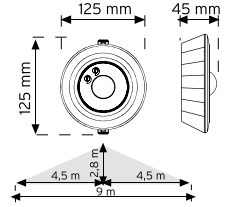

 Çalışma Gerilimi 230-240V - 50/60Hz	 Aydınlatma Yüğü 1000 W / 400 W	 Algılama Etki Alanı Max. 9 m ↔	 Algılama Yüksekliği 2.8 m	 Zaman Ayarı 5 sn ~ 5 dk	 Gün Işığı Ayarı 2-2000 lux	 Çalışma Sıcaklığı -20°C ~ +40°C	 Koruma Derecesi II Sınıfı	 Koli Bilgisi 8 kg 32 Adet 47,50x28,00x27,50
---	--	--	---	---	--	---	--	--



10362

85,00 TL



- 360° algılama açısı
- 360° dönebilen gövde
- Sıva altı kolay montaj
- Ayarlanabilir zaman ve lux özelliği
- Dijital kontrol sayesinde hatasız algılama

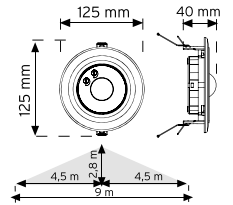

 Çalışma Gerilimi 230-240V - 50/60Hz	 Aydınlatma Yüğü 1000 W / 400 W	 Algılama Etki Alanı Max. 9 m ↔	 Algılama Yüksekliği 2.8 m	 Zaman Ayarı 5 sn ~ 5 dk	 Gün Işığı Ayarı 2-2000 lux	 Montaj Kesim Çapı Ø115 mm	 Çalışma Sıcaklığı -20°C ~ +40°C	 Koruma Derecesi II Sınıfı	 Koli Bilgisi 8 kg 32 Adet 47,50x28,00x27,50
---	--	--	---	---	--	---	--	---	--



360° SPOT TIPI HAREKET SENSÖRÜ

SENSÖR VE SENSÖRLÜ AYDINLATMA SİSTEMLERİ









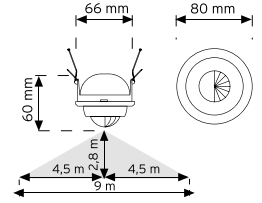



10365

90,00 TL



- 360° hareket sensörü sayesinde her yönde algılama
- 30° sağa-sola hareketli sensör
- Sıva altı kolay montaj
- Ayarlanabilir zaman ve lux özelliği
- Dijital kontrol sayesinde hatasız algılama
- Açık ayar aparatı sayesinde 30°-360° ayarlayabilme



 Çalışma Gerilimi 230-240V - 50/60Hz	 Aydınlatma Yüğü 1000 W / 400 W	 Algılama Etki Alanı Max. 9 m ↔	 Algılama Yüksekliği 2.8 m	 Zaman Ayarı 10 sn ~ 6 dk	 Gün Işığı Ayarı 2-2000 lux	 Montaj Kesim Çapı Ø70 mm	 Çalışma Sıcaklığı -20°C ~ +40°C	 Koruma Derecesi II Sınıfı	 Koli Bilgisi 6,5 kg 40 Adet 47,50x38,00x18,00	 3 YEARS GUARANTY	 TS EN 60669-2-1
---	--	--	---	--	--	--	--	---	--	---	--







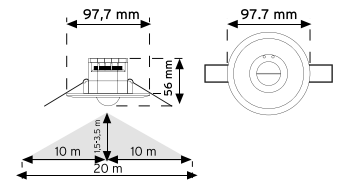

10366

90,00 TL



- HF sensör teknolojisi sayesinde her yönden algılama
- Duvar, alçıpan ve cam arkasından algılama
- Sıva altı kolay montaj
- Ayarlanabilir zaman, lux ve mesafe özelliği
- Dijital kontrol sayesinde hatasız algılama



 Çalışma Gerilimi 230V - 50/60Hz	 Aydınlatma Yüğü 2000 W / 800 W	 Algılama Etki Alanı 2 - 10 m ↔	 Algılama Yüksekliği 1.5 m - 3.5 m	 Zaman Ayarı 10 sn ~ 30 dk	 Gün Işığı Ayarı 10-500 lux	 Çalışma Sıcaklığı -20°C ~ +40°C	 Koruma Derecesi II Sınıfı	 3 YEARS GUARANTY	 TS EN 60669-2-1
---	--	--	---	---	--	---	--	---	--

TAVAN TIPI HF (RADAR) SENSÖRÜ

SENSÖR VE SENSÖRLÜ AYDINLATMA SİSTEMLERİ

10367

90,00 TL



- HF sensör teknolojisi sayesinde her yönden algılama
- Duvar, alçıpan ve cam arkasından algılama
- Sıva üstü kolay montaj
- Ayarlanabilir zaman, lux ve mesafe özelliği
- kontrol sayesinde hatasız algılama

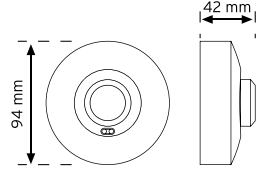

Çalışma Gerilimi	Aydınlatma Yüğü	Algılama Etki Alanı	Algılama Yüksekliği	Zaman Ayarı	Gün Işığı Ayarı	Çalışma Sıcaklığı	Koruma Derecesi
230-240V - 50/60Hz	1200 W / 600 W	360° 1-10 m (çap) →	2.5 m	10 sn ~ 30 dk	2-2000 lux	-20°C ~ +40°C	IP 20 II Sınıfı



10901

150,00 TL



- HF sensör teknolojisi sayesinde her yönden algılama
- Duvar, alçıpan ve cam arkasından algılama
- Sıva üstü kolay montaj
- Ayarlanabilir zaman, lux ve mesafe özelliği
- Dijital kontrol sayesinde hatasız algılama

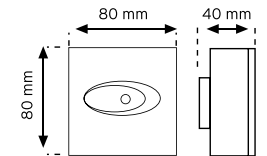

Çalışma Gerilimi	Aydınlatma Yüğü	Algılama Etki Alanı	Algılama Yüksekliği	Zaman Ayarı	Gün Işığı Ayarı	Çalışma Sıcaklığı	Koruma Derecesi	Koli Bilgisi
230-240V - 50/60Hz	1000 W / 400 W	360° 6-14 m →	2.8 m	10 sn ~ 5 dk	2-2000 lux	-20°C ~ +40°C	IP 20 II Sınıfı	8 kg 50 Adet 34,50x27,50x27,00



DUVAR TİPİ HF (RADAR) SENSÖRÜ

SENSÖR VE SENSÖRLÜ AYDINLATMA SİSTEMLERİ

10912

150,00 TL



- HF sensör teknolojisi sayesinde her yönden algılama
- Duvar, alçıpan ve cam arkasından algılama
- Sıva üstü kolay montaj
- Ayarlanabilir zaman, lux ve mesafe özelliği
- Dijital kontrol sayesinde hatasız algılama

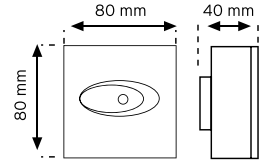

Çalışma Gerilimi	Aydınlatma Yüğü	Algılama Etki Alanı	Algılama Yüksekliği	Zaman Ayarı	Gün Işığı Ayarı	Çalışma Sıcaklığı	Koruma Derecesi	Koli Bilgisi
 230-240V - 50/60Hz	 1000 W / 400 W	 6-25 m →	 2.2 m	 10 sn ~ 5 dk	 2-2000 lux	 -20°C ~ +40°C	 II Sınıfı	 8 kg 50 Adet 34,50x27,50x27,00



TS EN 60669-2-1
CE

SWITCH TİPİ HAREKET SENSÖRÜ

SENSÖR VE SENSÖRLÜ AYDINLATMA SİSTEMLERİ

10100

90,00 TL



- 3 Konumlu anahtar ile AUTO, ON/OFF mod seçenekleri
- Sıva üstü ve sıva altı kolay montaj
- Tavanda ve duvarda kullanılabilme özelliği

- Ayarlanabilir zaman ve lux özelliği
- Dijital kontrol sayesinde hatasız algılama
- Tavanda 360°, duvarda 180° algılama açısı

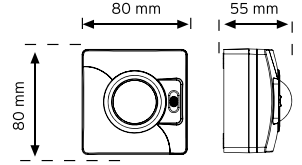

 Çalışma Gerilimi 230-240V - 50/60Hz	 Aydınlatma Yüğü 1000 W / 400 W	 Algılama Etki Alanı 360° 180°	 Algılama Yüksekliği 2.8 m / 1-2 m	 Zaman Ayarı 10 sn ~ 5 dk	 Gün Işığı Ayarı 2-2000 lux	 Çalışma Sıcaklığı -20°C ~ +40°C	 Koruma Derecesi II Sınıfı	 Koli Bilgisi 7 kg 48 Adet 34,50x27,50x27,00
---	--	--	---	--	--	---	--	--



10100 GRİ



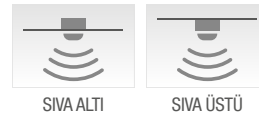



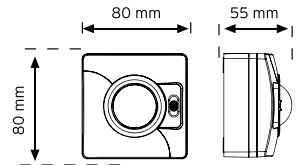

110,00 TL



- 3 Konumlu anahtar ile AUTO, ON/OFF mod seçenekleri
- Sıva üstü ve sıva altı kolay montaj
- Tavanda ve duvarda kullanılabilme özelliği

- Ayarlanabilir zaman ve lux özelliği
- Dijital kontrol sayesinde hatasız algılama
- Tavanda 360°, duvarda 180° algılama açısı



 Çalışma Gerilimi 230-240V - 50/60Hz	 Aydınlatma Yüğü 1000 W / 400 W	 Algılama Etki Alanı 360° 180°	 Algılama Yüksekliği 2.8 m / 1-2 m	 Zaman Ayarı 10 sn ~ 5 dk	 Gün Işığı Ayarı 2-2000 lux	 Çalışma Sıcaklığı -20°C ~ +40°C	 Koruma Derecesi II Sınıfı	 Koli Bilgisi 7 kg 48 Adet 34,50x27,50x27,00
---	--	--	---	--	--	---	--	--



180° DUVAR TİPİ HAREKET SENSÖRÜ

SENSÖR VE SENSÖRLÜ AYDINLATMA SİSTEMLERİ

10180

66,00 TL



- Sağa-sola 120°, yukarı-aşağı 30° döndürülebilir sensör
- Ayarlanabilir zaman ve lux özelliği
- Dijital kontrol sayesinde hatasız algılama
- 180° algılama açısı

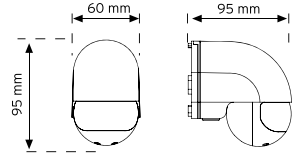

Çalışma Gerilimi	Aydınlatma Yüğü	Algılama Etki Alanı	Algılama Yüksekliği	Zaman Ayarı	Gün Işığı Ayarı	Çalışma Sıcaklığı	Koruma Derecesi	Koli Bilgisi
								
230-240V - 50/60Hz	1000 W / 400 W	Max. 12 m →	2.2 m	5 sn ~ 5 dk	2-2000 lux	-20°C ~ +40°C	II Sınıfı	7 kg 36 Adet 31,00x27,50x32,00



LED SÜRÜCÜLER

SENSÖR VE SENSÖRLÜ AYDINLATMA SİSTEMLERİ

SABİT AKIM LED SÜRÜCÜLER



Ürün Kodu	Güç (W)	Giriş Gerilimi (Vac)	Çıkış gerilimi (Vdc)	Çıkış Akımı (mA)	Frekans (Hz.)	Güç Faktörü (pF)	Boyutlar	Fiyat
222888	3W	90-240V	9-16V	300	50-60	> 0.95	88x39x23mm	Fiyat Sorunuz
222889	6W	90-240V	9-20V	300	50-60	> 0.95	88x39x23mm	Fiyat Sorunuz
222890	9W	90-240V	25-40V	300	50-60	> 0.95	104x38x24mm	Fiyat Sorunuz
222891	12W	90-240V	25-40V	300	50-60	> 0.95	104x38x24mm	Fiyat Sorunuz
222892	15W	90-240V	38-56V	300	50-60	> 0.95	104x38x24mm	Fiyat Sorunuz
222893	18W	90-240V	38-56V	300	50-60	> 0.95	104x38x24mm	Fiyat Sorunuz
222894	18W	90-240V	80-120V	300	50-60	> 0.50	88x39x23mm	Fiyat Sorunuz
222895	24W	185-265V	80-120V	300	50-60	> 0.50	88x39x23mm	Fiyat Sorunuz
222896	24W	200-240V	27-42V	500	50-60	> 0.95	160x48x34mm	Fiyat Sorunuz
222897	36W	185-265V	80-120V	300	50-60	> 0.50	88x39x23mm	Fiyat Sorunuz
222898	36W	200-240V	27-42V	720	50-60	> 0.95	160x48x34mm	Fiyat Sorunuz
222899	40W	200-240V	27-42V	960	50-60	> 0.95	160x48x34mm	Fiyat Sorunuz
222900	44W	200-240V	27-42V	1050	50-60	> 0.95	160x48x34mm	Fiyat Sorunuz
222901	50W	200-240V	30-42V	1200	50-60	> 0.95	160x54x32mm	Fiyat Sorunuz
222902	55W	200-240V	30-42V	1400	50-60	> 0.95	160x54x32mm	Fiyat Sorunuz



ANCHALIGHTING®

LIGHTING FOR LIFE



na·De®

www.na-de.com.tr - info@na-de.com.tr

MERKEZ: İstanbul Deri Organize Sanayi Bölgesi, Tuş Sokak No:8 M1-8 Özel Parsel, Tuzla / İstanbul

FABRİKA: İstanbul Deri Organize Sanayi Bölgesi, Sama Caddesi No:8 M1-5 Özel Parsel, Tuzla / İstanbul

☎ 0216 394 01 55 - 0216 394 01 56

0216 394 05 30 - 0216 394 01 98

☎ 0216 394 25 73

0216 394 01 64

 **DMY**
ELEKTRONİK İYATIRIMLAR

49
YIL



/nadeelektronik



/nadeelektronik



/na-de-elektronik



BORDO ÇÖZÜMEVİ REKL.
SAN.VE TIC.LTD.ŞTİ.
25.12.2017